

# EMI电源滤波器

## EMI POWER LINE FILTERS

---

以专业的设计和可靠的质量来回馈用户的关注



北京爱科创业电子技术有限公司  
Beijing EMCARE Electronic Technology Co.,Ltd.

# COMPANY PROFILE

## 公司简介



北京爱科创业电子技术有限公司是一家专业从事EMI电源滤波器及EMC相关产品设计制造和EMC技术服务的技术型公司。公司有以多位电磁兼容专业博士为技术带头人的研发队伍，技术力量雄厚。公司自成立以来，始终坚持以专业技术为依托，通过自身的技术实力不断为客户提供专业的EMI电源滤波器产品和EMC技术服务。公司在市场推广上尤为注重现场技术服务和针对客户需求的个性化设计，最终协助客户完成系统EMC自兼容和产品EMC达标等方面的电磁兼容设计。

北京爱科创业电子技术有限公司的EMI电源滤波器产品广泛适用于高速铁路、航空航天、军用设备、医疗设备、电力电子设备、变频设备、开关电源、电源系统、数字电路、检测设备、通信设备、电动设备等产品。

公司的执行方针是：以专业的设计和可靠的质量来回馈用户的关注。

Beijing EMCARE Electronic Technology Co., Ltd. is a technology-based company specializing in the design and manufacture of EMI Power Line Filter and EMC-related products and EMC technical services. The company has a research and development team with a number of EMC professional doctors as technical leaders and strong technical force. Since its establishment, the company has always adhered to relying on professional technology and continuously provided customers with professional EMI Power Line Filter products and EMC technical services through its own technical strength. The company pays special attention to on-site technical services and personalized design for customer needs in market promotion, and finally assists customers to complete EMC design for system EMC self-compatibility and product EMC compliance.

EMI Power Line Filter products of Beijing EMCARE Electronic Technology Co., Ltd. are widely used in high-speed railway, aerospace, military equipment, medical equipment, power electronic equipment, frequency conversion equipment, switching power supply, power supply system, digital circuit, detection equipment, communication equipment, electric equipment and other equipment.

The executive policy of the company is to return users' attention with professional design and reliable quality.

# PREFACE

## 序言

### EMI滤波器的插入损耗测试方法

Test method for Insertion Loss of EMI filter

插入损耗是表征滤波器对噪声的衰减能力的参数。实际上常采用50Ω的测试系统进行测量。其定义如下：

Insertion Loss is a parameter characterizing the attenuation ability of the filter to noise. In fact, 50 Ω test system is often used for measurement. It is defined as follows:

$$IL = 20\log(V_1/V_2)$$

式中 IL:插入损耗,单位dB;

V1: 负载与信号源直接连接时,负载上的电压;

V2: 负载通过滤波器与信号源连接时,负载上的电压。

Where IL: Insertion Loss, unit: dB;

V1: voltage on the load when the load is directly connected to the signal source;

V2: voltage on the load when the load is connected to the signal source through the filter.

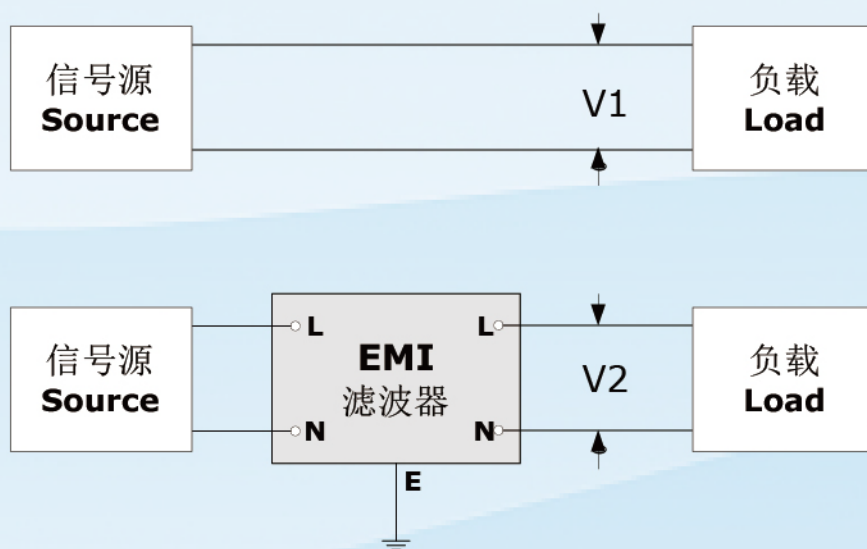

Fig.1 插入损耗定义的示意图

Fig. 1 Schematic diagram of insertion loss definition

插入损耗又分为共模插入损耗和差模插入损耗，分别表征对共模噪声和差模噪声的抑制能力。常规滤波器共/差模插入损耗的测试遵循CISPR No.17 (GB7343)的标准规定。具体测试电路如下图所示。

Insertion Loss is divided into common-mode insertion loss and differential-mode insertion loss, which respectively represent the ability to suppress common-mode noise and differential-mode noise. The common/differential mode insertion loss test of conventional filter follows the standard provisions of CISPR No.17 (GB7343). The specific test circuit is shown in the figure below.

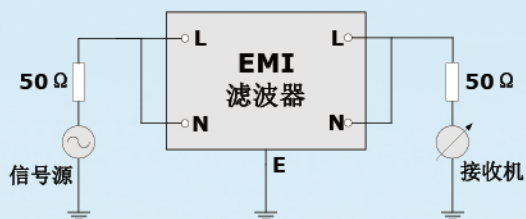

Fig.2 共模插入损耗的测试方法

Figure 2 Test method of common-mode insertion loss

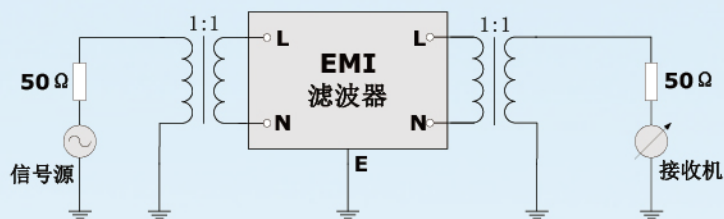

Fig.3 差模插入损耗的测试方法

Fig. 3 Test method of differential mode insertion loss

## 滤波器选型对策

Countermeasures for filter selection

### 根据应用场合来选

Select according to the application

首先需要考虑的是滤波器的类型(单相、三相、直流等等)、滤波器的额定电流和结构尺寸等因素。

The first thing to consider is the type of filter (single-phase, three-phase, DC, etc.), the rated current and structure size of the filter.

另外,实际上还常常会根据滤波器应用中特殊的耐压、漏电流、工作环境温度范围等条件来选取滤波器。

In addition, in fact, the filter is often selected according to the special withstand voltage, leakage current, operating environment temperature range and other conditions in the filter application.

### 根据应用标准来选

Select according to the involved standards

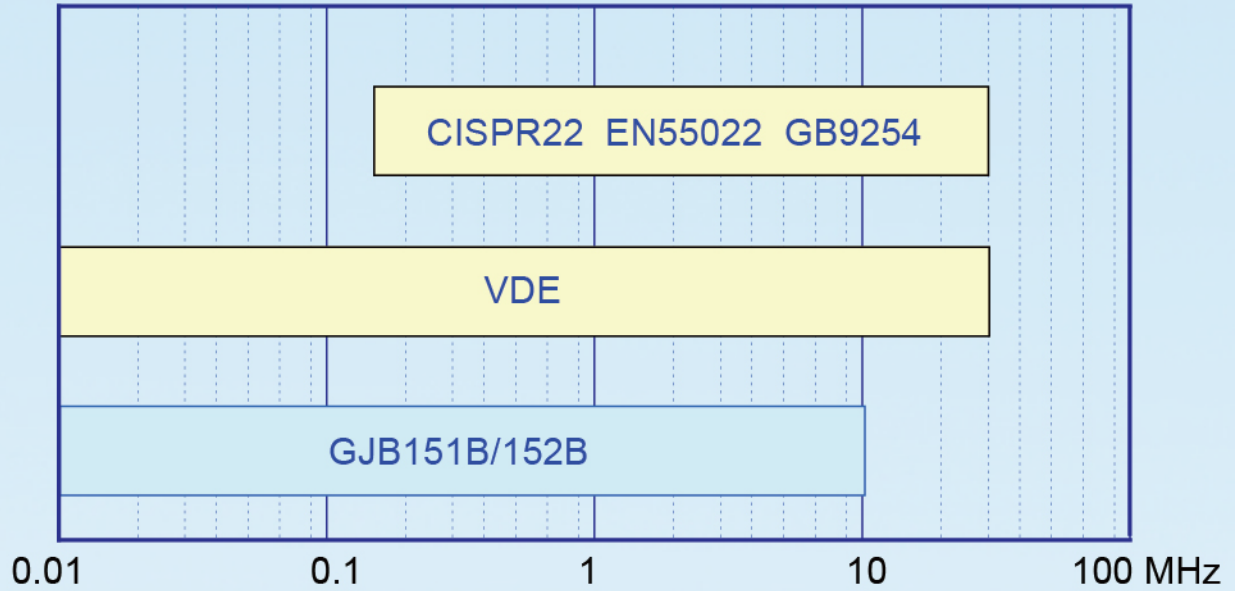

Fig.4 不同标准对传导发射所要求的测试频段

Fig. 4 Test frequency band required by different standards for conducted emission

由于不同标准对传导发射测量的频段各不相同,所以在选择滤波器之前需考虑被测设备所需遵循的标准。并在对应标准所要求的频段内提出对滤波器插入损耗的要求。

Because different standards have different frequency bands for conducting emission measurement, the standards to be followed by the tested equipment should be considered before selecting the filter. The insertion loss of the filter is required within the frequency band required by the corresponding standard.

#### ◎ 根据设备的传导发射值来选

Select according to the excess value of conducted emission of equipment

滤波器的共模插入损耗代表滤波器对共模噪声的抑制能力,而差模插入损耗则代表滤波器对差模噪声的抑制能力。理论上讲,对滤波器插入损耗的需求就等于传导发射超过标准限值的值。首先需要对噪声模式进行判断,然后计算相对应模式的插入损耗要求。

The common-mode insertion loss of the filter represents the filter's ability to suppress common-mode noise, while the differential-mode insertion loss represents the filter's ability to suppress differential-mode noise. Theoretically, the demand for filter insertion loss is equal to the value of conducted emission exceeding the standard limit. First, it is necessary to judge the noise mode, and then calculate the insertion loss requirements of the corresponding mode.

当然这只是理论计算的判断,最终还需要通过安装滤波器后所进行的实际传导发射测试来确定滤波器插损的需求值。

Of course, this is only the judgment of theoretical calculation. Finally, the required value of filter insertion loss needs to be determined through the actual conducted emission test after the filter is installed.

## 滤波器使用注意事项

Precautions for filter use

### ① 滤波器输入端在机箱内走线尽可能短

The wiring of the filter input end in the cabinet shall be as short as possible

如果滤波器的输入端在机箱内走线过长,那么滤波器的输入端在机箱内的电缆就会成为高效的接收天线,这样机箱内的噪声就会耦合到滤波器的输入端电缆上。结果会大大降低滤波器对噪声的衰减,尤其是对高频噪声。

If the input end of the filter is routed too long in the case, the cable of the input end of the filter in the case will become an efficient receiving antenna, so that the noise in the case will be coupled to the input end cable of the filter. The result will greatly reduce the noise attenuation of the filter, especially for high-frequency noise.

### ② 避免滤波器的输入端和输出端的耦合

Avoid coupling of the input and output ends of the filter

实际安装滤波器常常会出现滤波器输出和输入端距离过近的错误,这样由于滤波器输入和输出的耦合作用旁路了滤波器。这样的安装方法会显著降低滤波器的性能。

The error that the distance between the output and the input of the filter is too close often occurs when the filter is actually installed, which bypasses the filter due to the coupling effect of the filter input and output. Such installation method will significantly reduce the performance of the filter.

### ③ 滤波器可靠接地

Filter reliably grounded

滤波器可靠接地是指滤波器外壳的安装面要与机箱实现面 and 面的导电接触。而仅仅通过接地电源线接地常常在高频下表现为接地不良,这是因为在高频条件下电源线的电感使得接地阻抗剧烈上升而导致滤波器出现高阻接地的情况。

The reliable grounding of the filter refers to the conductive contact between the mounting surface of the filter and the surface of the chassis. However, grounding only through the grounding power line often shows poor grounding at high frequency. This is because the inductance of the power line causes a sharp rise in the grounding impedance at high frequency, resulting in high resistance grounding of the filter.



# **MILITARY FILTERS**

## **军用滤波器**

### **军用单相系列**

Military Single-Phase Series

### **军用三相三线系列**

Military Three-Phase Series

### **军用三相四线系列**

Military Three-Phase+Neutral Series

### **军用直流系列**

Military DC Series

### **军用PCB插装系列**

Military PCB Plug-in Series

### **军用谐波抑制系列**

Military Harmonic Suppression Series

## 军用单相系列

## Military Single-Phase Series

- 专门针对单相军用电子设备通过GJB151B/GJB152B中CE102的传导发射要求设计  
Special single-phase circuit design for CE102 of GJB151B/GJB152B
- 显著降低开关频率的高次谐波对电源线的干扰, 解决开关电源/逆变器产生的EMC和EMI问题  
Depressing harmonic disturbance of switch frequency, handle the EMC and EMI problem of switch/converter

### 技术规格 Specification

额定电压 Rated Voltage	250VAC/400VDC		
工作频率 Operating Frequency	DC~400Hz		
介质耐压 Hipot Test Voltage	线-线(L-L)	1768VDC	1分钟 1min
	线-地(L-E)	2000VAC	
气候等级 Climatic Classification	55/085/21		遵循IEC68-1标准 Per IEC68-1 standard

型号 Model	额定电流 Rated Current	最大漏电流 Max. Leakage	外形尺寸 Mechanical Data	端接方式 Connections	
				输入 Input	输出 Output
MS10-1AW	1A	<0.5mA	Fig.1		
MS10-2AW	2A	<0.5mA	Fig.1		
MS10-2BL	2A	<0.5mA	Fig.2		
MS10-3AW	3A	<0.5mA	Fig.1		
MS10-3CL	3A	<0.5mA	Fig.3		
MS10-3HL	3A	<0.5mA	Fig.4		
MS10-6HL	6A	<0.5mA	Fig.5		
MS10-6CL	6A	<0.5mA	Fig.3		
MS10-10HL	10A	<0.5mA	Fig.5		

05

军用滤波器

MILITARY FILTERS

军用单相系列

Military Single-Phase Series



型号	额定电流	最大漏电流	外形尺寸	端接方式	
Model	Rated Current	Max. Leakage	Mechanical Data	Connections	
				输入 Input	输出 Output
MS10-10ES	10A	<0.5mA	Fig.6		
MS10-20ES	20A	<0.5mA	Fig.6		
MS10-20FS	20A	<0.8mA	Fig.7		
MS10-30JS	30A	<0.8mA	Fig.8		
MS10-50JS	50A	<1.0mA	Fig.9		

\*漏电流测试条件为250VAC/50Hz

\*The leakage current test condition is 250VAC/50Hz

### 插入损耗 Insertion Loss

遵循CISPR No.17/GB7343标准, 插入损耗是在输入/输出均为50Ω的条件下的测量值。

CM (共模) \_\_\_\_\_ DM (差模) \_\_\_\_\_

According to CISPR No.17/GB7343 standard, the insertion loss is the measured value under the condition that the input/output is 50 Ω.

\_\_\_\_\_ denotes Common Mode Insertion Loss, \_\_\_\_\_ denotes Differential Mode Insertion Loss.

MS10-1AW

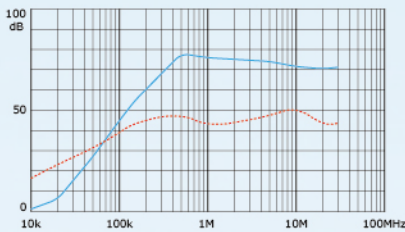

MS10-2AW

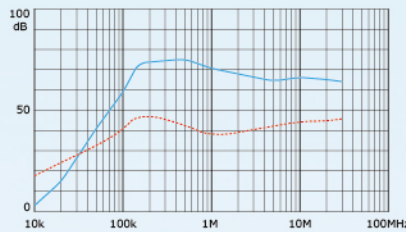

MS10-2BL

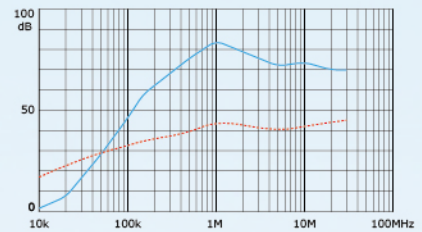

MS10-3AW

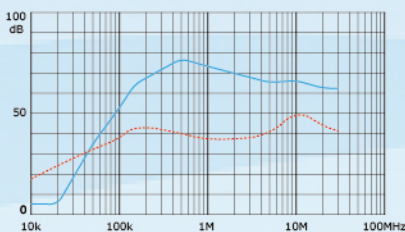

MS10-3CL

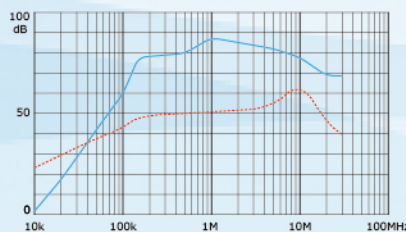

MS10-3HL

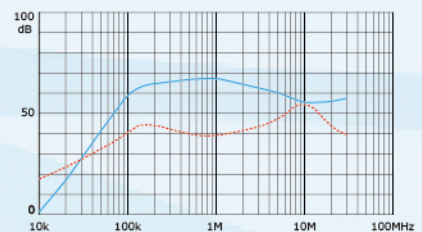

MS10-6HL

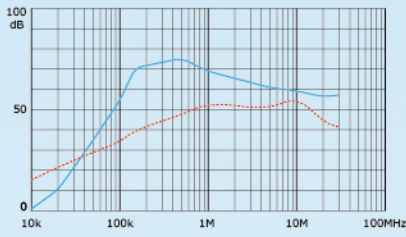

MS10-6CL

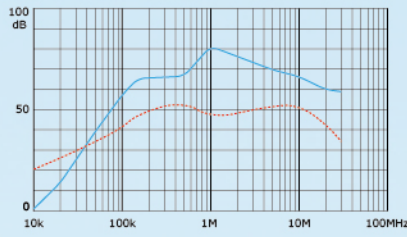

MS10-10HL

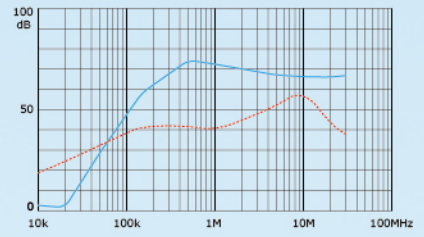

MS10-10ES

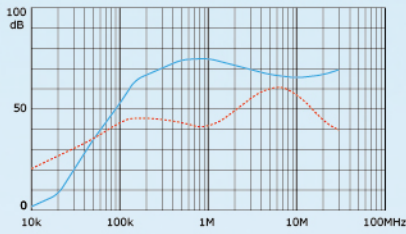

MS10-20ES

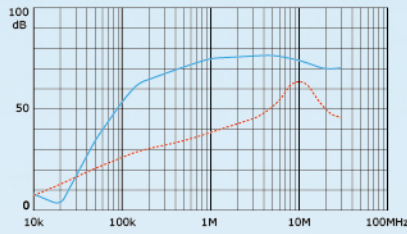

MS10-20FS

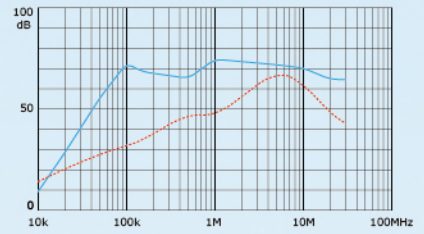

MS10-30JS

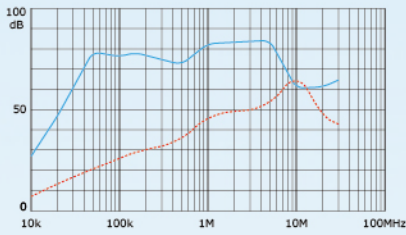

MS10-50JS

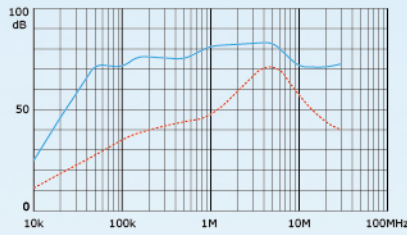

外形尺寸  
Mechanical Data

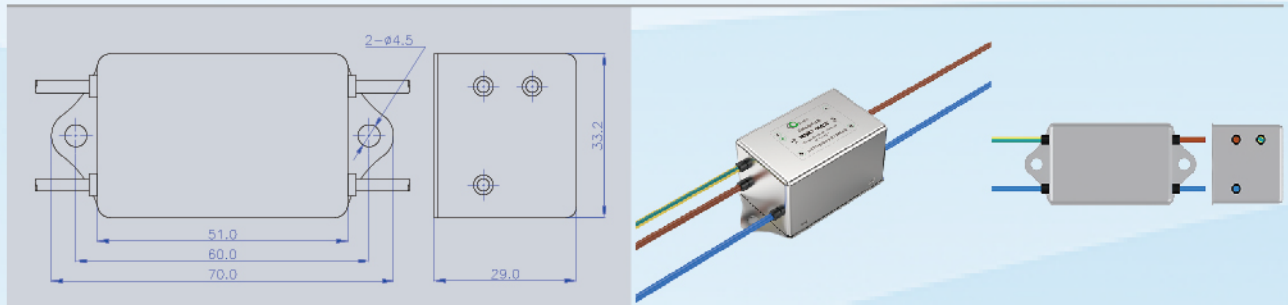

Fig.1

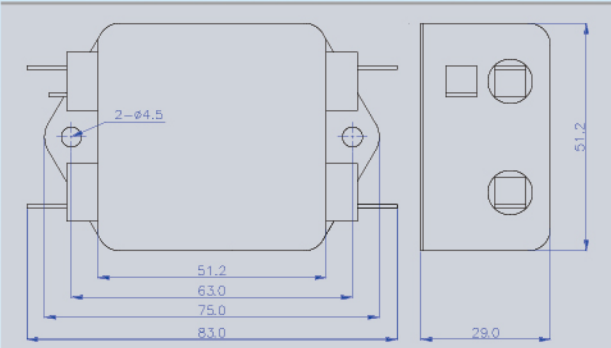

Fig.2

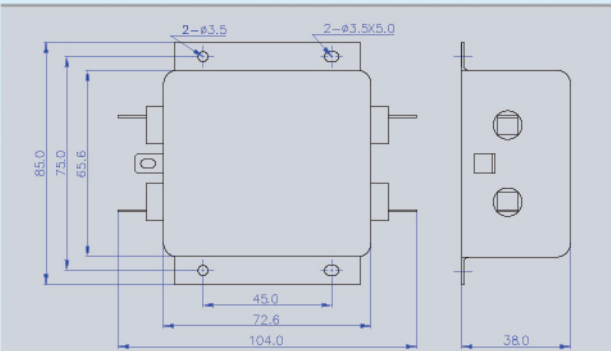
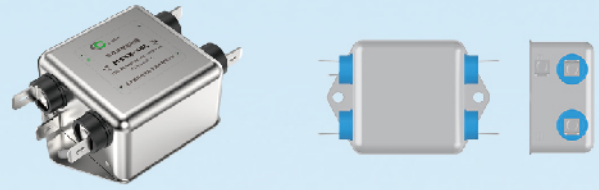

Fig.3

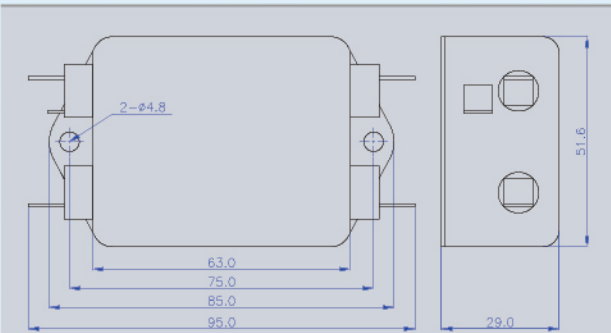
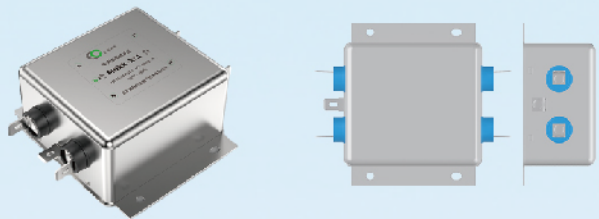

Fig.4

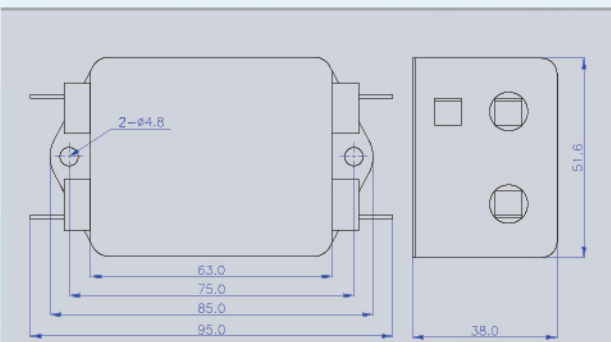
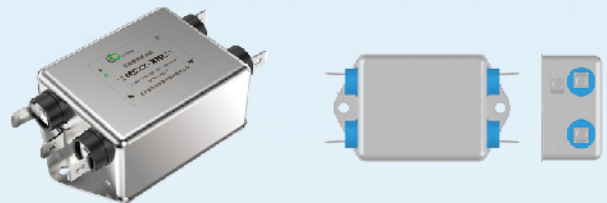
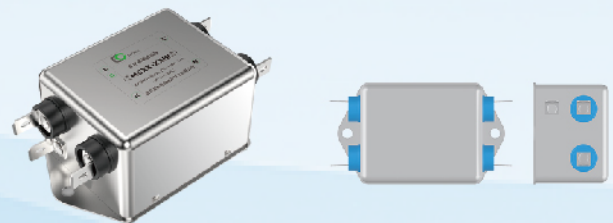

Fig.5



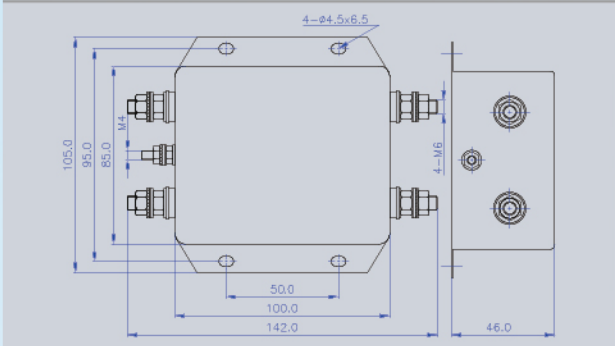

Fig.6

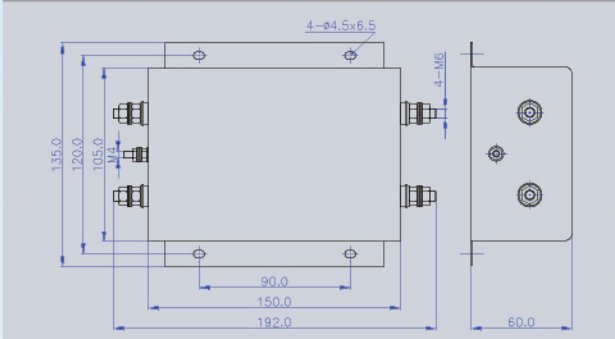
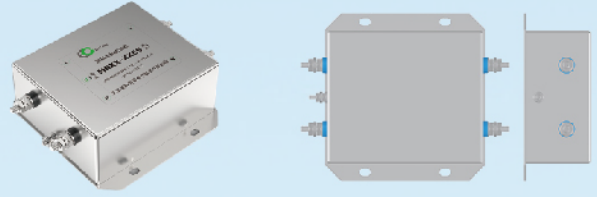

Fig.7

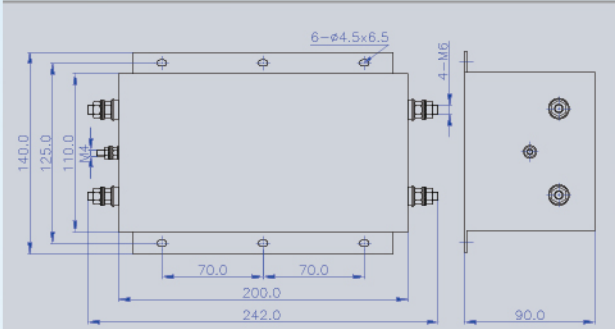
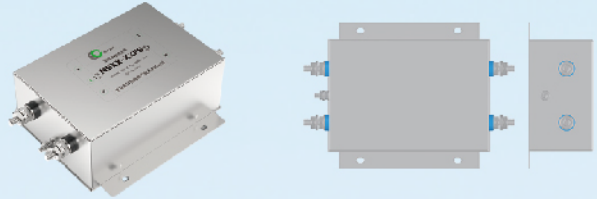

Fig.8

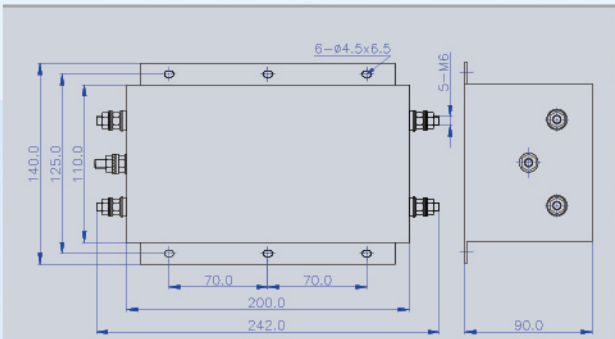
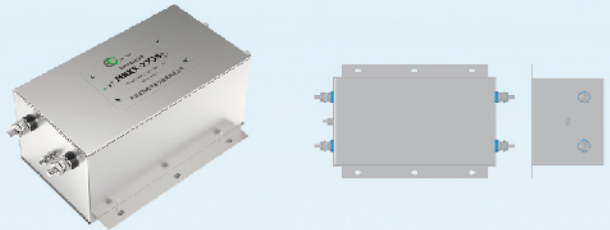
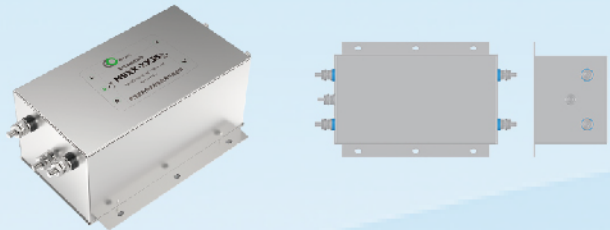

Fig.9



## 军用三相三线系列

## Military Three-Phase Series

- 专门针对军用三相电子设备通过GJB151B/GJB152B中CE102的传导发射要求设计  
Special three-phase circuit design for CE102 of GJB151B/GJB152B
- 显著降低开关频率的高次谐波对电源线的干扰, 解决开关电源/逆变器产生的EMC和EMI问题  
Depressing harmonic disturbance of switch frequency, handle the EMC and EMI problem of switch/converter

### 技术规格 Specification

额定电压 Rated Voltage	440VAC		
工作频率 Operating Frequency	DC~400Hz		
介质耐压 Hipot Test Voltage	线-线(L-L)	2250VDC	1分钟 1min
	线-地(L-E)	2700VDC	
气候等级 Climatic Classification	55/085/21		遵循IEC68-1标准 Per IEC68-1 standard

型号 Model	额定电流 Rated Current	最大漏电流 Max. Leakage	外形尺寸 Mechanical Data	端接方式 Connections	
				输入 Input	输出 Output
MT10-6ES	6A	<1.0mA	Fig.1		
MT10-10GS	10A	<1.0mA	Fig.2		
MT10-20FS	20A	<1.0mA	Fig.3		
MT10-30KS	30A	<1.0mA	Fig.4		
MT10-50KS	50A	<1.0mA	Fig.5		
MT10-100KS	100A	<2.0mA	Fig.6		
MT10-150KS	150A	<2.0mA	Fig.6		
MT10-200KS	200A	<2.0mA	Fig.7		
MT10-300KE	300A	<5.0mA	Fig.8	母排	母排

# 军用滤波器

军用滤波器

MILITARY FILTERS

军用三相三线系列

Military Three-Phase Series

10



型号	额定电流	最大漏电流	外形尺寸	端接方式	
Model	Rated Current	Max. Leakage	Mechanical Data	Connections	
				输入 Input	输出 Output
MT10-400KE	400A	<5.0mA	Fig.8	母排	母排
MT10-500KE	500A	<5.0mA	Fig.8	母排	母排

\*漏电流测试条件为250VAC/50Hz

\*The leakage current test condition is 250VAC/50Hz



### 插入损耗

Insertion Loss

遵循CISPR No.17/GB7343标准,插入损耗是在输入/输出均为50Ω的条件下的测量值。

CM (共模) \_\_\_\_\_ DM (差模) \_\_\_\_\_

According to CISPR No.17/GB7343 standard, the insertion loss is the measured value under the condition that the input/output is 50 Ω.

\_\_\_\_\_ denotes Common Mode Insertion Loss, \_\_\_\_\_ denotes Differential Mode Insertion Loss.

MT10-6ES

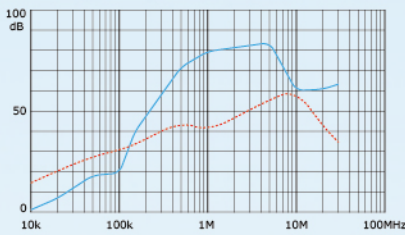

MT10-10GS

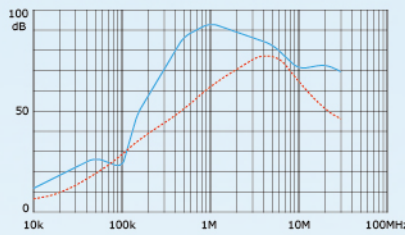

MT10-20FS

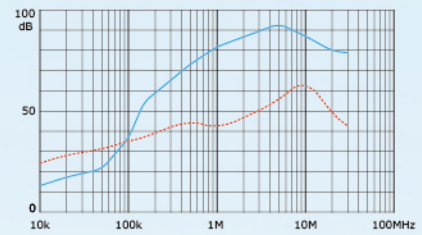

MT10-30KS

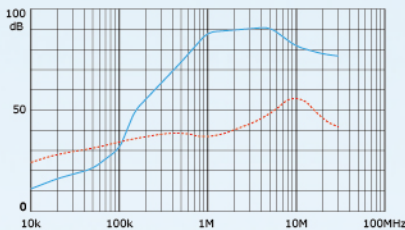

MT10-50KS

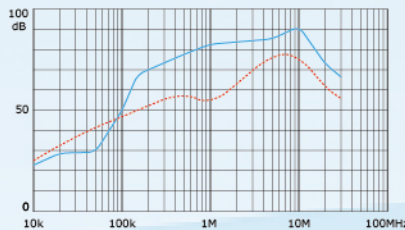

MT10-100KS

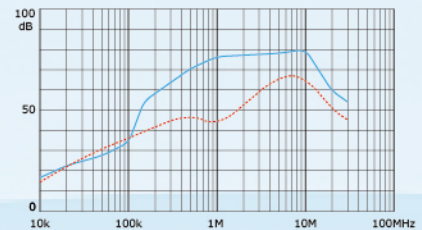

MT10-150KS

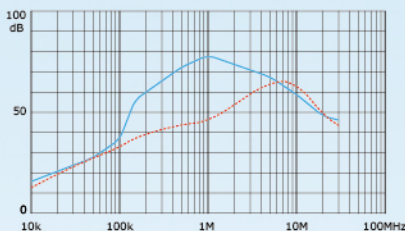

MT10-200KS

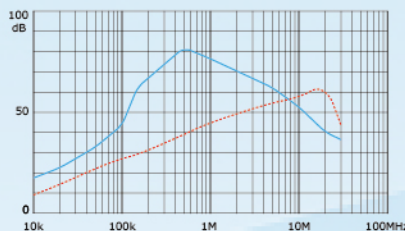

MT10-300KE

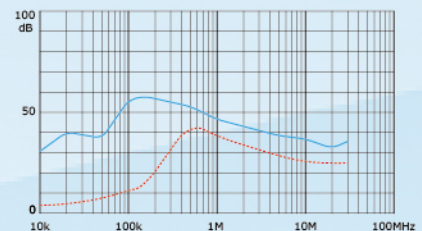

MT10-400KE

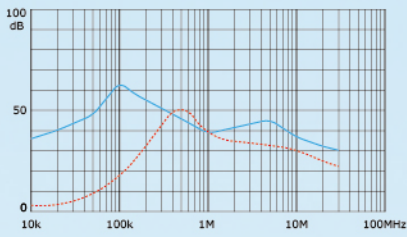

MT10-500KE

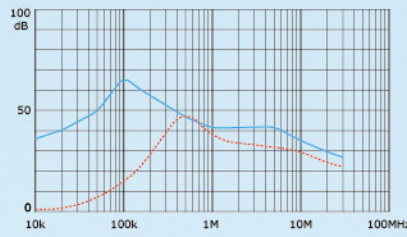

**外形尺寸**  
Mechanical Data

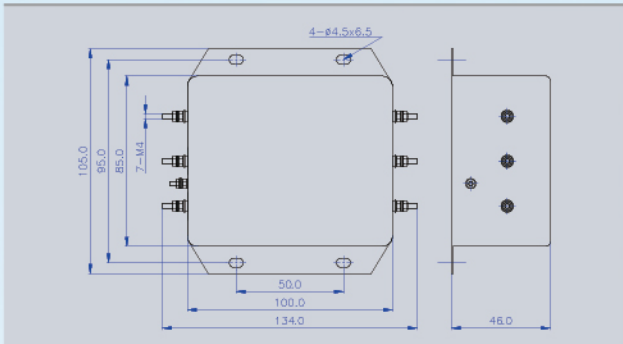

Fig.1

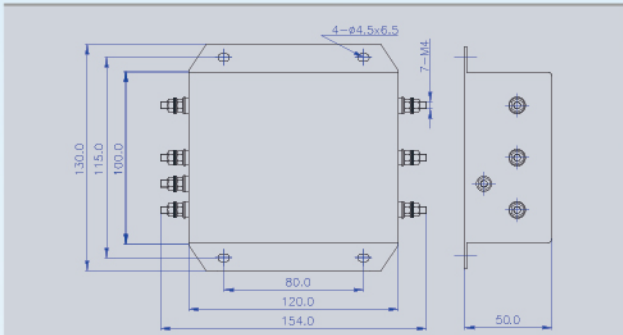
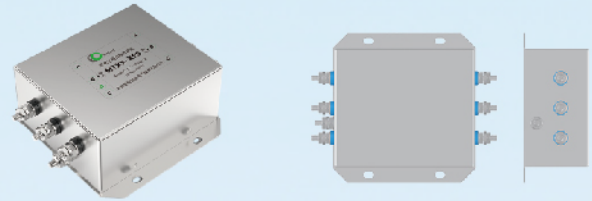

Fig.2

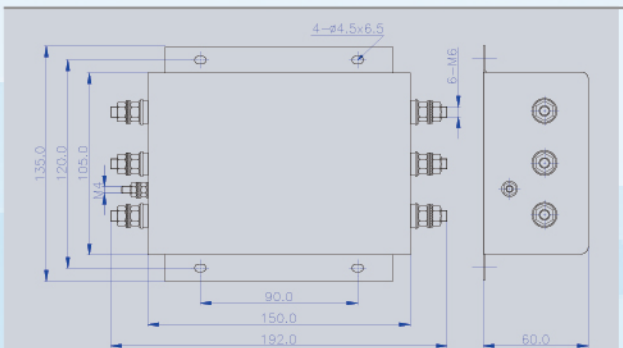
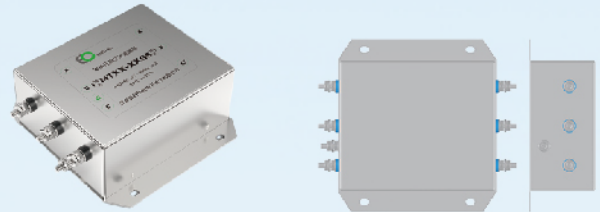
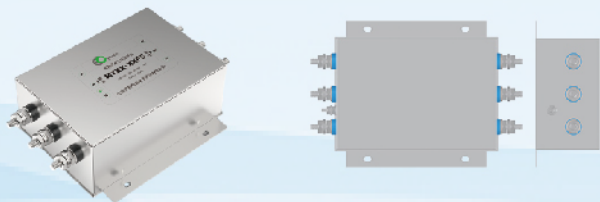

Fig.3



军用滤波器

军用滤波器

MILITARY FILTERS

军用三相三线系列

Military Three-Phase Series

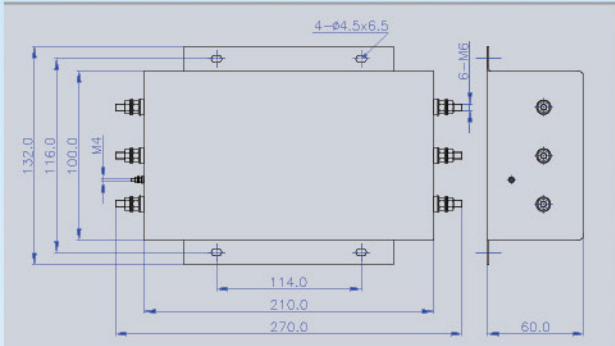

Fig.4

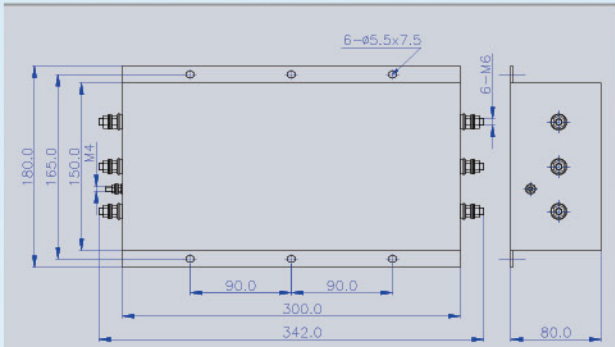

Fig.5

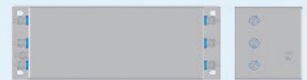
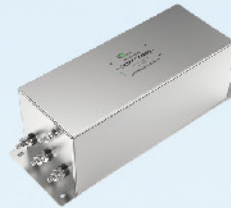
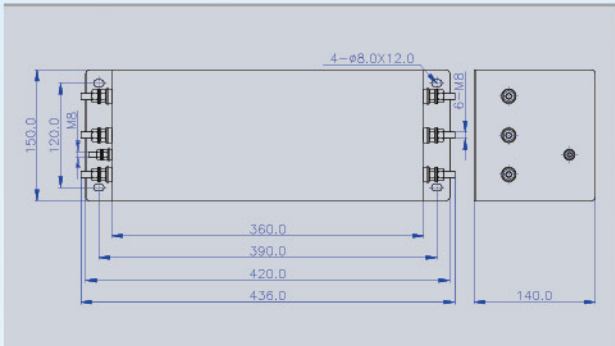

Fig.6

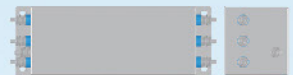
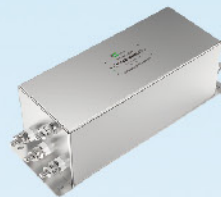
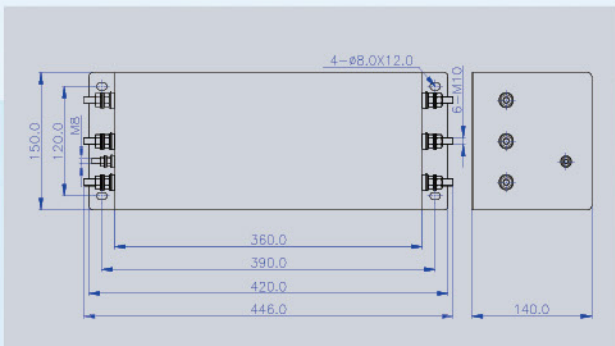

Fig.7



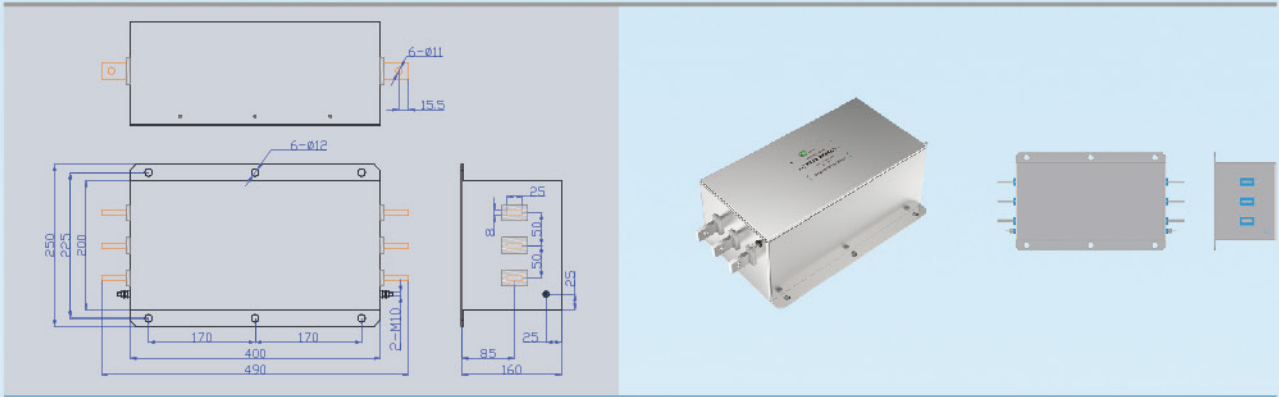

Fig.8

军用滤波器

军用滤波器

MILITARY FILTERS

军用三相三线系列

Military Three-Phase Series

14



## 军用三相四线系列

Military Three-Phase+Neutral Series

- 专门针对军用三相四线电子设备通过GJB151B/GJB152B中CE102的传导发射要求设计  
Special three-phase four lines circuit design for CE102 of GJB151B/GJB152B
- 显著降低开关频率的高次谐波对电源线的干扰,解决开关电源/逆变器产生的EMC和EMI问题  
Depressing harmonic disturbance of switch frequency, handle the EMC and EMI problem of switch/converter
- 在三相不平衡的供电条件下能保持正常工作  
To maintain performance generally for unbalance load

技术规格  
Specification

额定电压 Rated Voltage	440VAC		
工作频率 Operating Frequency	DC~400Hz		
介质耐压 Hipot Test Voltage	线-线(L-L)	2250VDC	1分钟 1min
	线-零(L-N)	1450VDC	
	线-地(L-E)	2700VDC	
气候等级 Climatic Classification	55/085/21		遵循IEC68-1标准 Per IEC68-1 standard

型号 Model	额定电流 Rated Current	最大漏电流 Max. Leakage	外形尺寸 Mechanical Data	端接方式 Connections	
				输入 Input	输出 Output
MQ10-6ES	6A	<1.0mA	Fig.1		
MQ10-10GL	10A	<1.0mA	Fig.2		
MQ10-20FS	20A	<1.0mA	Fig.3		
MQ10-30KS	30A	<1.0mA	Fig.4		
MQ10-50KS	50A	<1.0mA	Fig.4		
MQ10-60KS	60A	<1.0mA	Fig.5		







15

## 军用滤波器

MILITARY FILTERS

军用三相四线系列

Military Three-Phase+Neutral Series

型号	额定电流	最大漏电流	外形尺寸	端接方式	
Model	Rated Current	Max. Leakage	Mechanical Data	Connections	
				输入 Input	输出 Output
MQ10-100KS	100A	<1.0mA	Fig.6		
MQ10-150KS	150A	<1.0mA	Fig.6		
MQ10-200KS	200A	<2.0mA	Fig.7		
MQ10-300KE	300A	<5.0mA	Fig.8	母排	母排
MQ10-400KE	400A	<5.0mA	Fig.8	母排	母排
MQ10-500KE	500A	<5.0mA	Fig.8	母排	母排

\*漏电流测试条件为250VAC/50Hz

\*The leakage current test condition is 250VAC/50Hz

### 插入损耗 Insertion Loss

遵循CISPR No.17/GB7343标准,插入损耗是在输入/输出均为50Ω的条件下的测量值。

CM (共模) ----- DM (差模) -----

According to CISPR No.17/GB7343 standard, the insertion loss is the measured value under the condition that the input/output is 50 Ω.

----- denotes Common Mode Insertion Loss, ----- denotes Differential Mode Insertion Loss.

MQ10-6ES

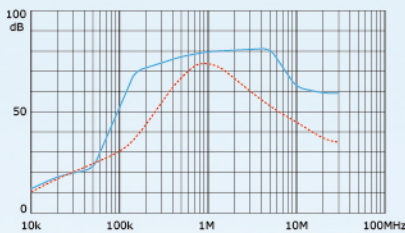

MQ10-10GL

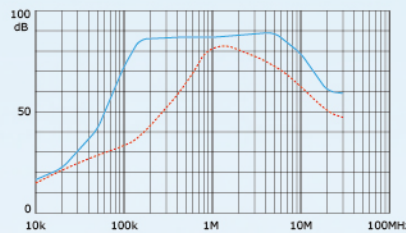

MQ10-20FS

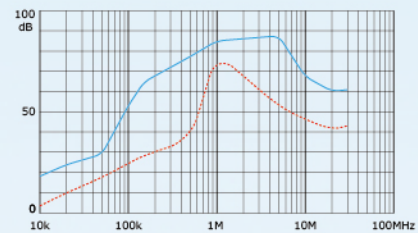

MQ10-30KS

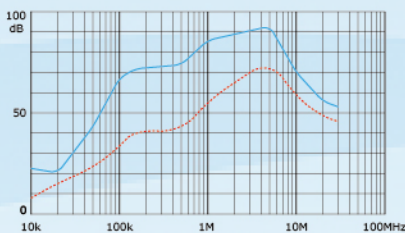

MQ10-50KS

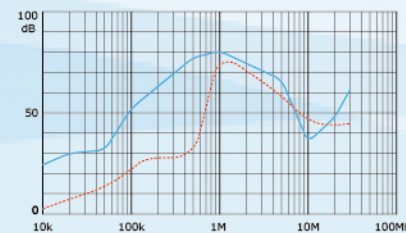

MQ10-60KS

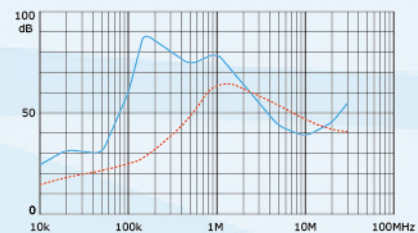

军用滤波器

MILITARY FILTERS

军用三相四线系列

Military Three-Phase+Neutral Series

16

MQ10-100KS

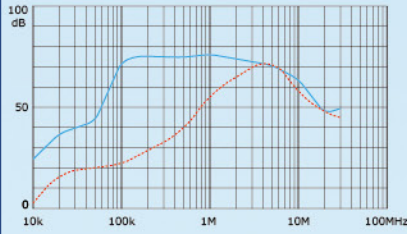

MQ10-150KS

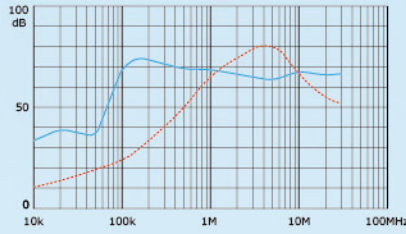

MQ10-200KS

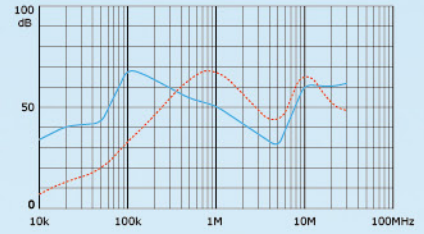

MQ10-300KE

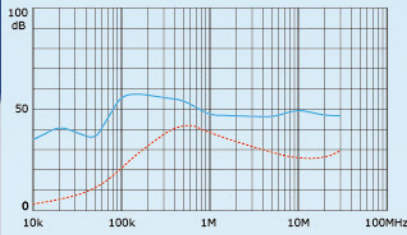

MQ10-400KE

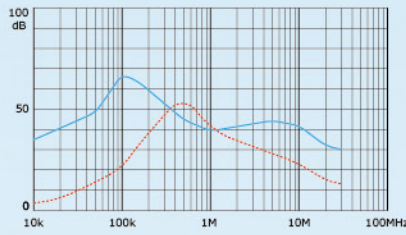

MQ10-500KE

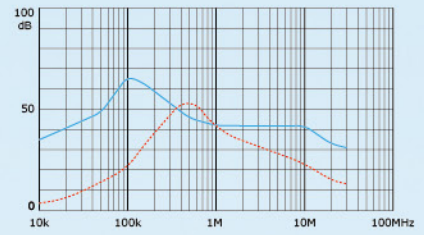

外形尺寸  
Mechanical Data

军用滤波器

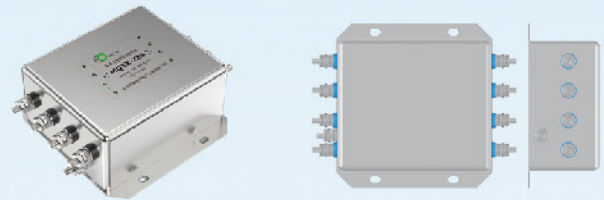
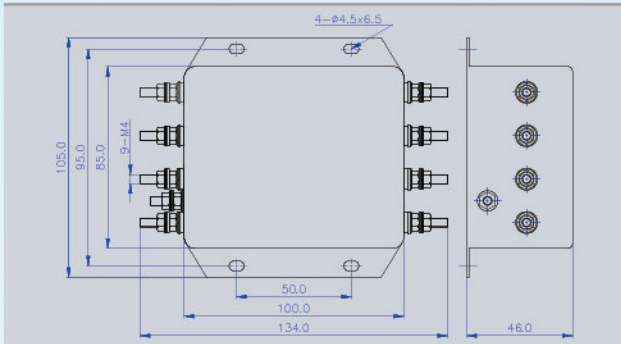

Fig.1

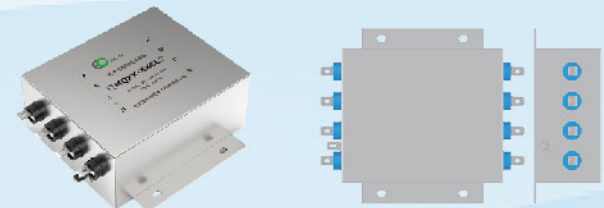
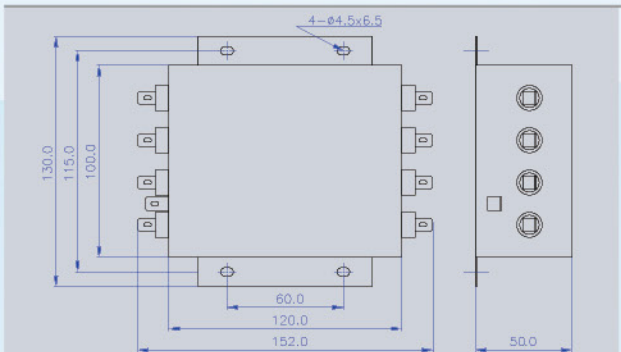

Fig.2

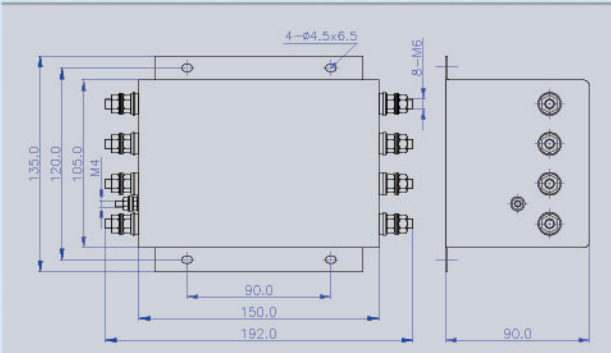

Fig.3

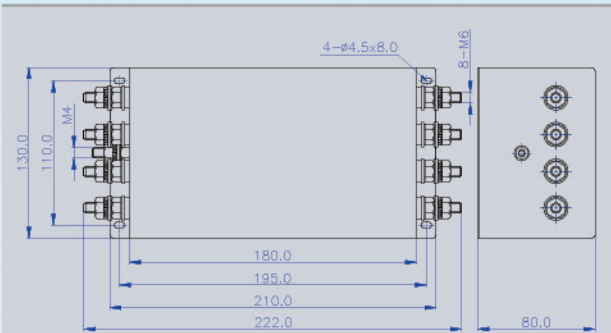
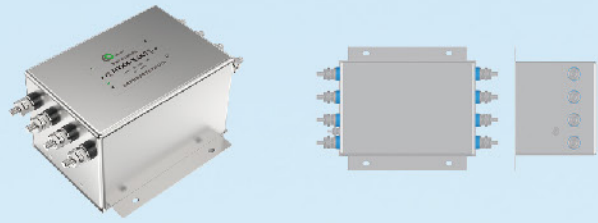

Fig.4

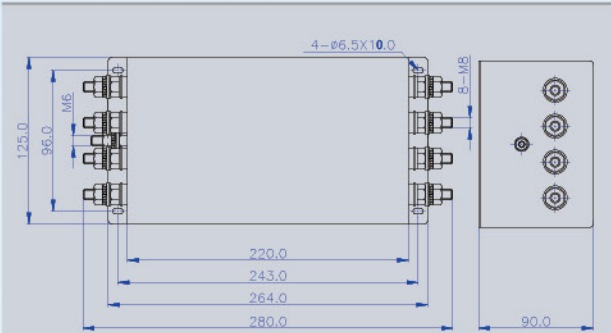
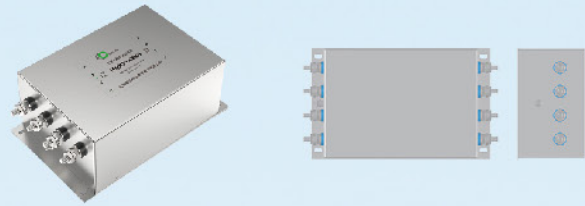

Fig.5

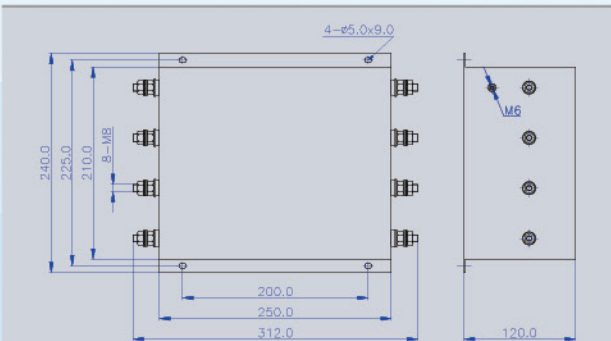
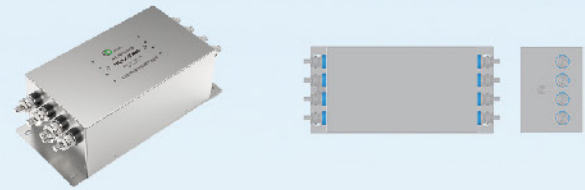
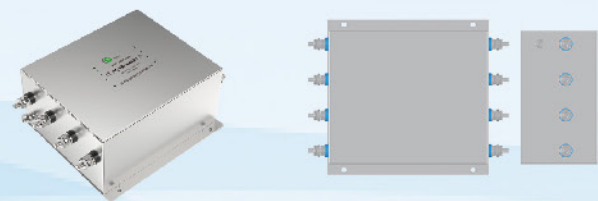

Fig.6



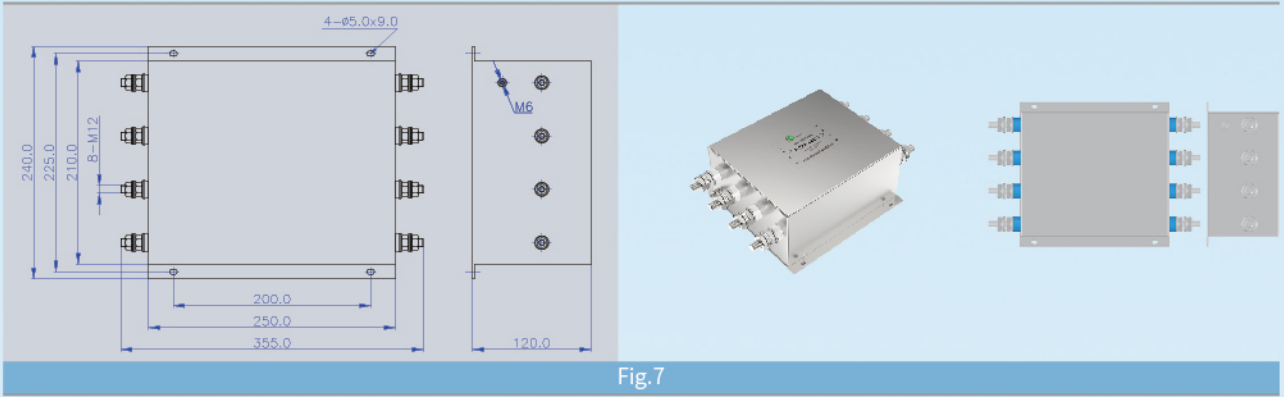

Fig.7

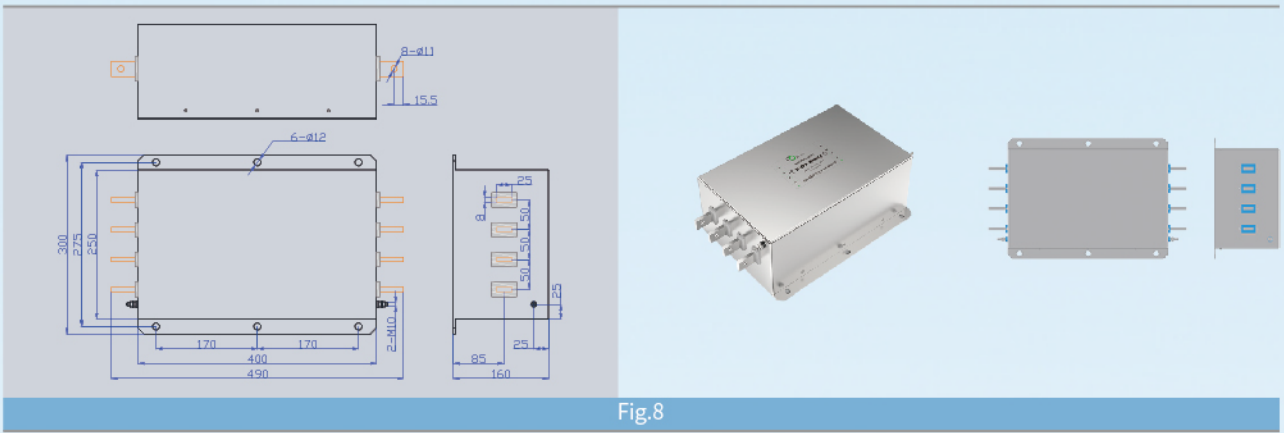

Fig.8

## 军用直流系列

## Military DC Series

- 专门针对军用直流电子设备通过GJB151B/GJB152B中CE102的传导发射要求设计  
Special DC circuit design for CE102 of GJB151B/GJB152B
- 显著降低直流电源的高/低频噪声, 提高电路的抗干扰能力, 解决系统内部产生的EMC和EMI问题  
Depressing harmonic disturbance of switch frequency, handle the EMC and EMI problem of switch/converter

### 技术规格 Specification

额定电压 Rated Voltage		40VDC	
介质耐压 Hipot Test Voltage	线-线(L-L)	80VDC	1分钟 1min
	线-地(L-E)	500VDC	
气候等级 Climatic Classification		55/085/21	遵循IEC68-1标准 Per IEC68-1 standard

型号 Model	额定电流 Rated Current	外形尺寸 Mechanical Data	端接方式 Connections	
			输入 Input	输出 Output
MD10-2DW	2A	Fig.1		
MD10-3AW	3A	Fig.2		
MD10-3DW	3A	Fig.1		
MD10-6BL	6A	Fig.3		
MD10-10BL	10A	Fig.3		
MD10-10ES	10A	Fig.4		
MD10-20ES	20A	Fig.5		
MD10-20FS	20A	Fig.6		
MD10-30FS	30A	Fig.6		
MD10-50FS	50A	Fig.6		

# 军用滤波器



插入损耗  
Insertion Loss

遵循CISPR No.17/GB7343标准,插入损耗是在输入/输出均为50Ω的条件下的测量值。

CM (共模) ----- DM (差模) -----

According to CISPR No.17/GB7343 standard, the insertion loss is the measured value under the condition that the input/output is 50 Ω.

----- denotes Common Mode Insertion Loss, ----- denotes Differential Mode Insertion Loss.

MD10-2DW

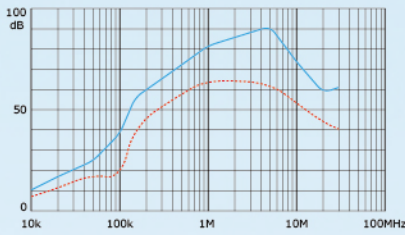

MD10-3AW

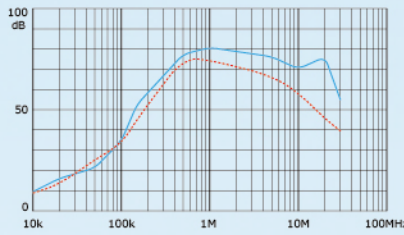

MD10-3DW

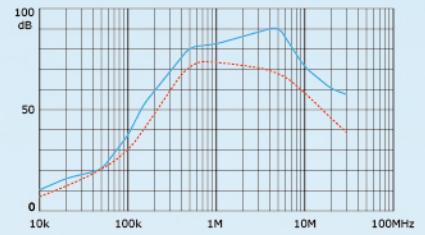

MD10-6BL

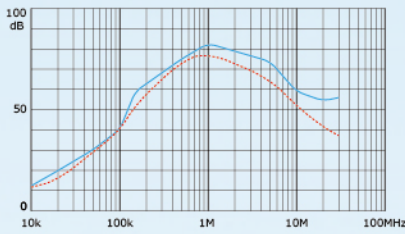

MD10-10BL

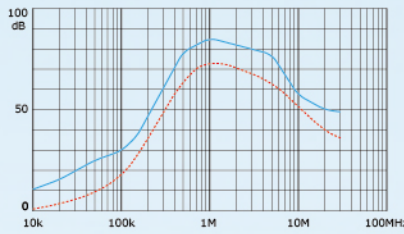

MD10-10ES

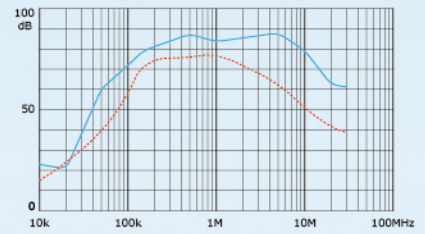

MD10-20ES

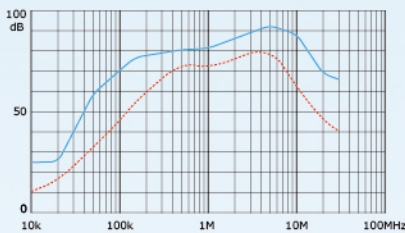

MD10-20FS

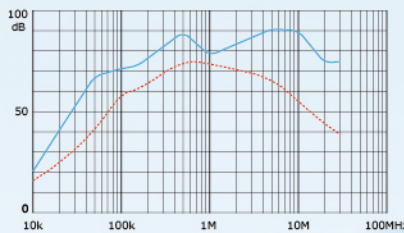

MD10-30FS

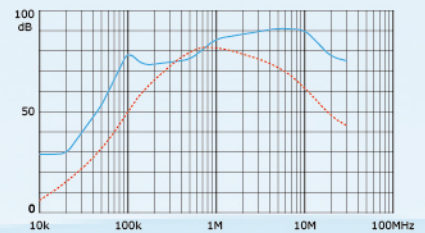

MD10-50FS

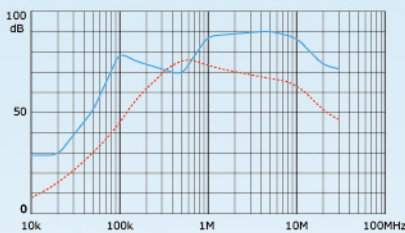



外形尺寸  
Mechanical Data

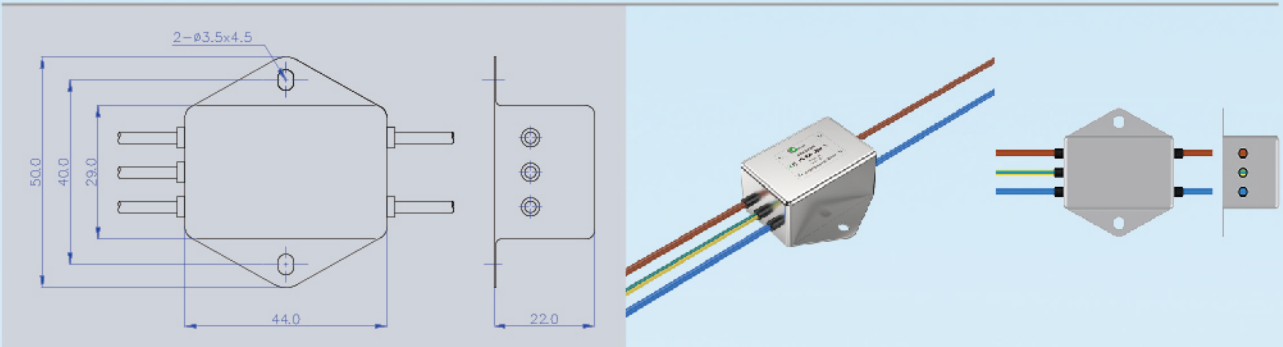

Fig.1

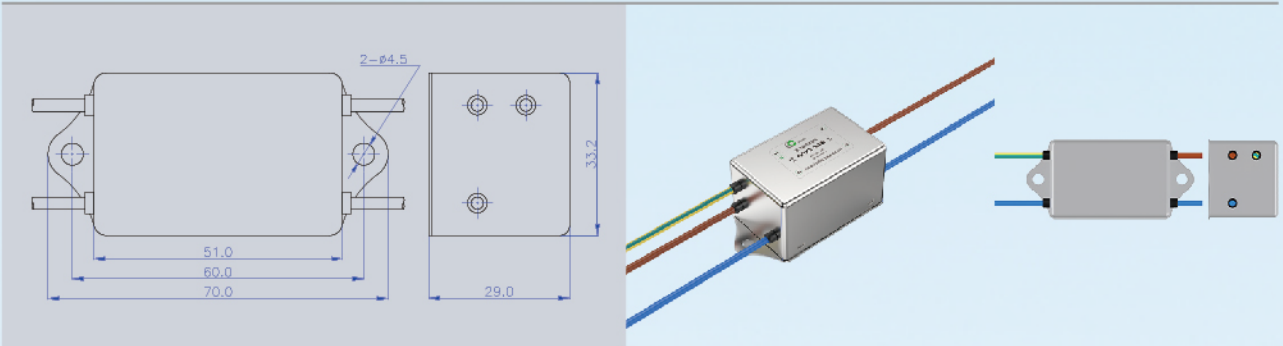

Fig.2

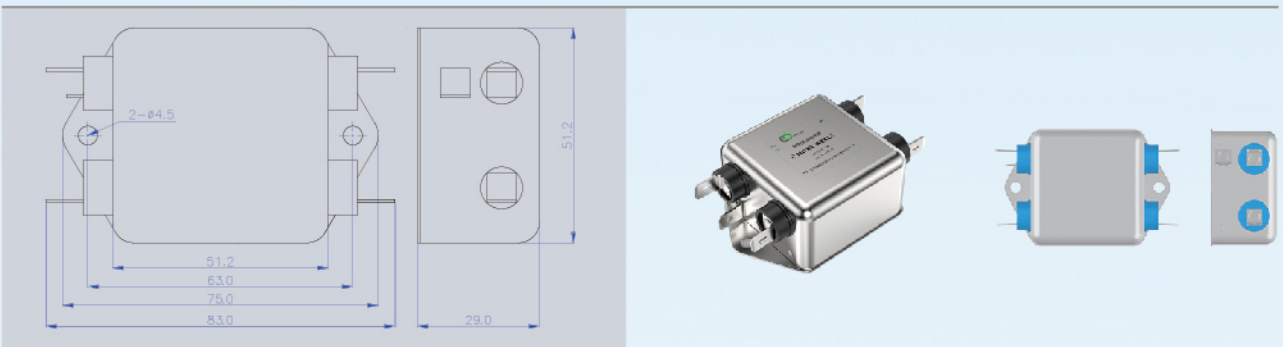

Fig.3

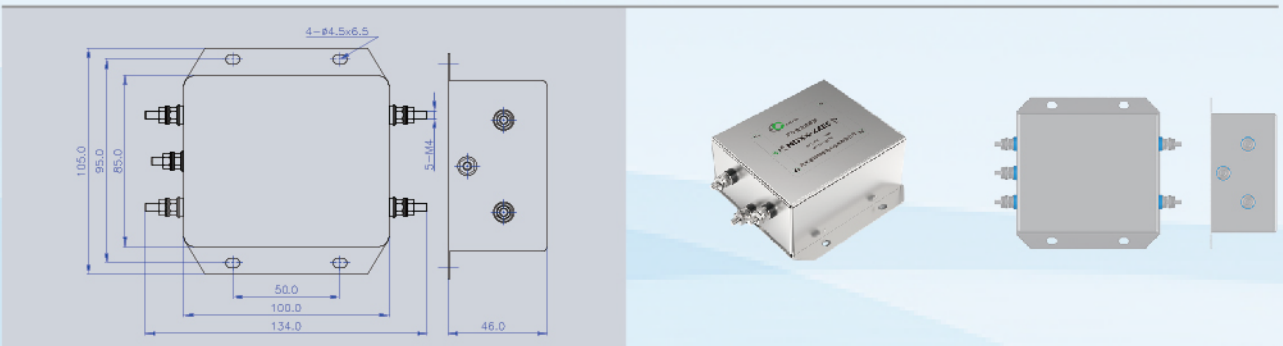

Fig.4

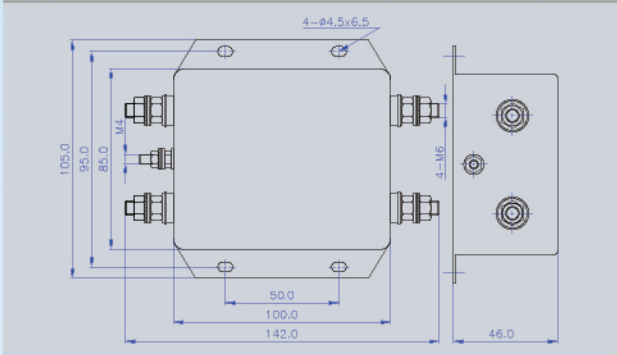

Fig.5

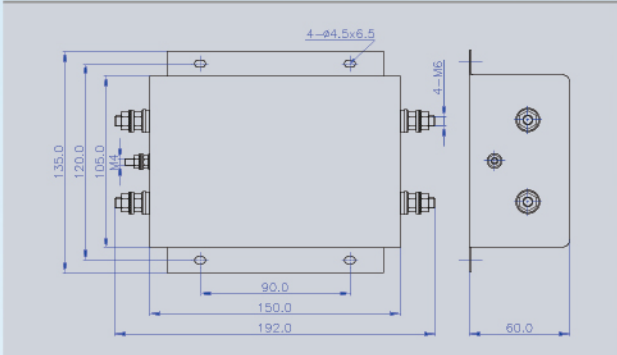
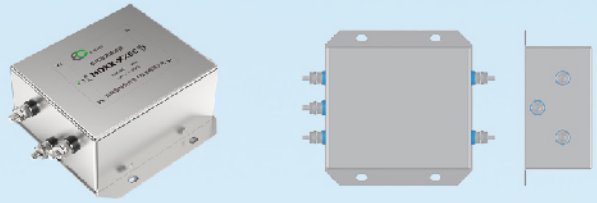
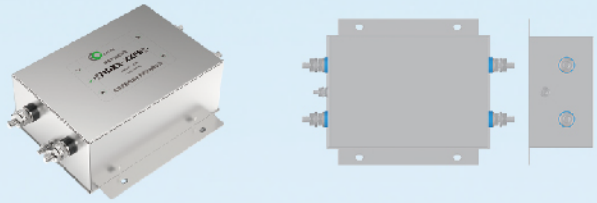

Fig.6



## 军用PCB插装系列

## Military PCB Plug-in Series

- ◎ 适合PCB的尺寸设计, 结构紧凑安装方便  
Suitable for PCB size design, compact structure and convenient installation
- ◎ 显著降低开关频率的高次谐波对电源线的干扰, 解决开关电源/逆变器产生的EMC和EMI问题  
Significantly reduce the interference of higher-order harmonics of switching frequency on power lines, and solve the EMC and EMI problems caused by switching power supply/inverter

### 技术规格 Specification

交流AC			
额定电压 Rated Voltage		250VAC/400VDC	
工作频率 Operating Frequency		DC~400Hz	
介质耐压 Hipot Test Voltage	线-线(L-L)	1768VDC	1分钟 1min
	线-地(L-E)	2000VAC	
气候等级 Climatic Classification		55/085/21	遵循IEC68-1标准 Per IEC68-1 standard

直流DC			
额定电压 Rated Voltage		80VDC	
介质耐压 Hipot Test Voltage	线-线(L-L)	160VDC	1分钟 1min
	线-地(L-E)	500VDC	
气候等级 Climatic Classification		55/085/21	遵循IEC68-1标准 Per IEC68-1 standard

# 军用滤波器

军用滤波器

MILITARY FILTERS

军用PCB插装系列

Military PCB Plug-in Series

24



型号	额定电流	最大漏电流	外形尺寸	端接方式	
Model	Rated Current	Max. Leakage	Mechanical Data	Connections	
				输入 Input	输出 Output
交流AC					
MB10-1PC	1A	<0.3mA	Fig.1		
MB10-3PC	3A	<0.3mA	Fig.1		
MB10-6PC	6A	<0.3mA	Fig.1		
直流DC					
MB50-3PC	3A	—	Fig.1		
MB50-6PC	6A	—	Fig.1		
MB60-10BC	10A	—	Fig.2		
MB60-20BC	20A	—	Fig.3		

\*漏电流测试条件为250VAC/50Hz

\*The leakage current test condition is 250VAC/50Hz



### 插入损耗 Insertion Loss

遵循CISPR No.17/GB7343标准,插入损耗是在输入/输出均为50Ω的条件下的测量值。

CM (共模) ----- DM (差模) -----

According to CISPR No.17/GB7343 standard, the insertion loss is the measured value under the condition that the input/output is 50 Ω.

----- denotes Common Mode Insertion Loss, ----- denotes Differential Mode Insertion Loss.

MB10-1PC

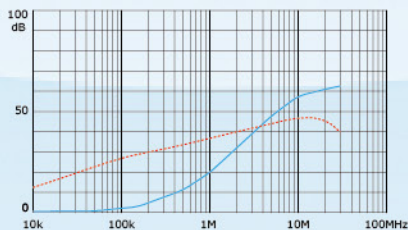

MB10-3PC

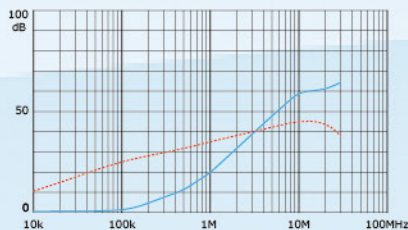

MB10-6PC

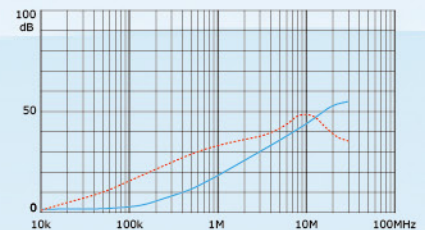

25

## 军用滤波器

MILITARY FILTERS

军用PCB插装系列

Military PCB Plug-in Series

MB50-3PC

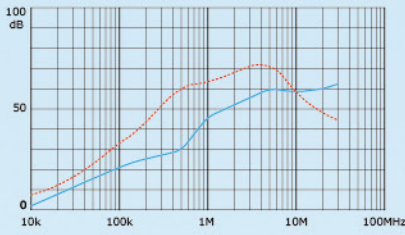

MB50-6PC

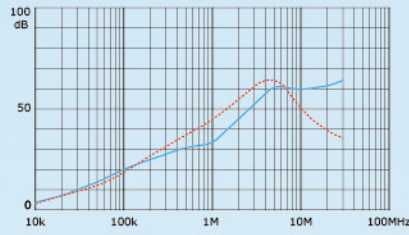

MB60-10BC

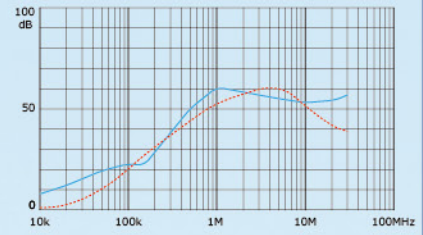

MB60-20BC

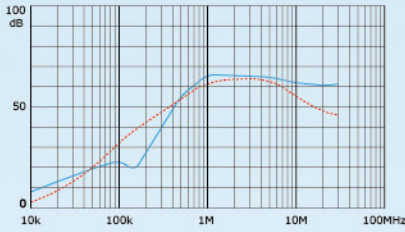

 外形尺寸  
Mechanical Data

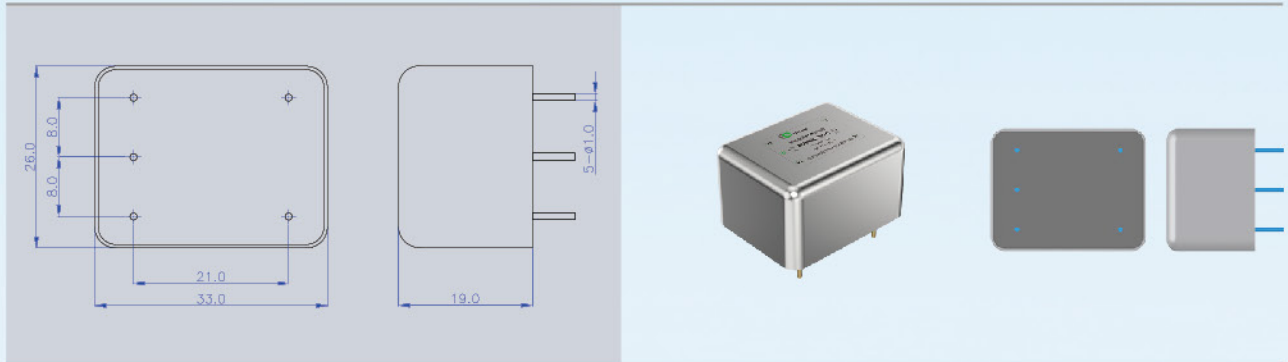

Fig.1

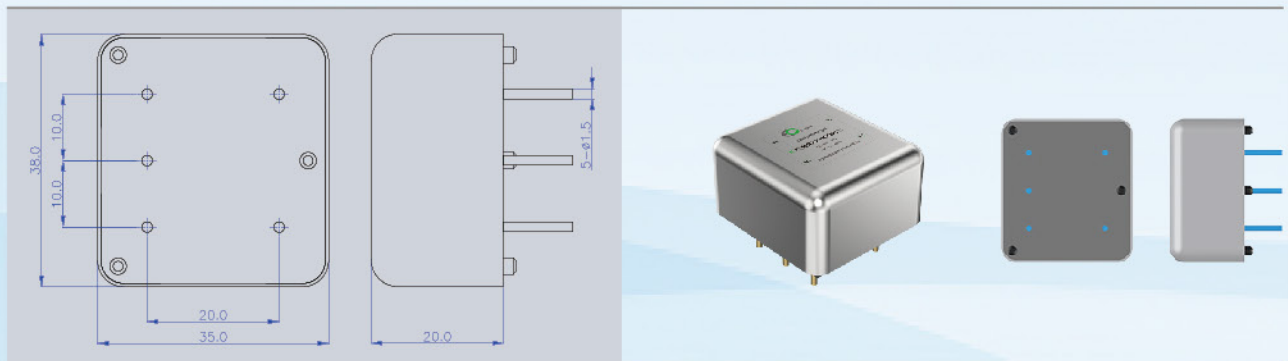
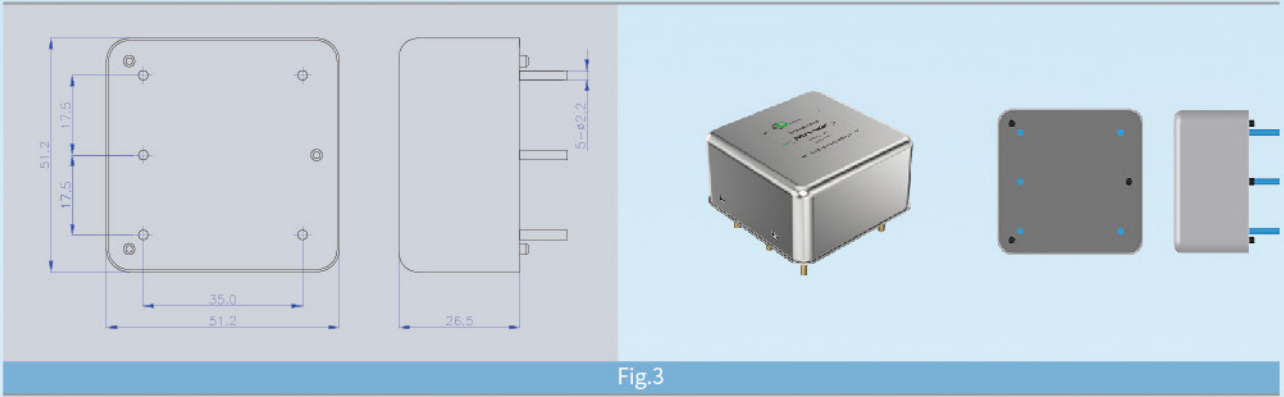

Fig.2



## 军用谐波抑制系列

## Military Harmonic Suppressor

- 专门针对军用直流电子设备通过GJB151B/GJB152B中CE101要求设计  
Special DC circuit design for CE101 of GJB151B/GJB152B
- 抑制谐波与电压跌落  
Reduction of harmonics and voltage drop
- 改善功率因数  
Improvement of Power Factor

### 技术规格 Specification

额定电压 Rated Voltage		250VAC	
工作频率 Operating Frequency		50/60Hz	
介质耐压 Hipot Test Voltage	线一地(L-E)	2000VAC	1分钟 1min
气候等级 Climatic Classification		55/085/21	遵循IEC68-1标准 Per IEC68-1 standard

型号 Model	额定电流 Rated Current	外形尺寸 Mechanical Data	端接方式 Connections	
			输入 Input	输出 Output
P010-1TW	1A	Fig.1	↑	↑
P010-2TW	2A	Fig.1	↑	↑
P010-3TW	3A	Fig.1	↑	↑
P010-6TW	6A	Fig.1	↑	↑
P010-10TW	10A	Fig.1	↑	↑

# 军用滤波器



外形尺寸  
Mechanical Data

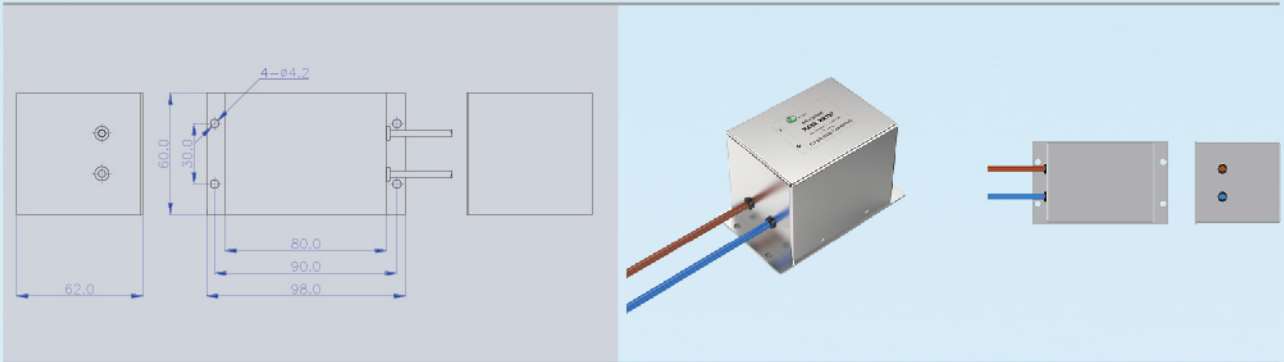

Fig.1



北京爱科创业电子技术有限公司  
Beijing EMCARE Electronic Technology Co.,Ltd.

---

 010-82922019

 400-0160-309

 010-82922657

 [www.emcare.com.cn](http://www.emcare.com.cn)

 [sales@emcare.com.cn](mailto:sales@emcare.com.cn)



企业微信



淘宝自营