

EMI电源滤波器

EMI POWER LINE FILTERS

以专业的设计和可靠的质量来回馈用户的关注



北京爱科创业电子技术有限公司
Beijing EMCARE Electronic Technology Co.,Ltd.

COMPANY PROFILE

公司简介



北京爱科创业电子技术有限公司是一家专业从事EMI电源滤波器及EMC相关产品设计制造和EMC技术服务的技术型公司。公司有以多位电磁兼容专业博士为技术带头人的研发队伍，技术力量雄厚。公司自成立以来，始终坚持以专业技术为依托，通过自身的技术实力不断为客户提供专业的EMI电源滤波器产品和EMC技术服务。公司在市场推广上尤为注重现场技术服务和针对客户需求的个性化设计，最终协助客户完成系统EMC自兼容和产品EMC达标等方面的电磁兼容设计。

北京爱科创业电子技术有限公司的EMI电源滤波器产品广泛适用于高速铁路、航空航天、军用设备、医疗设备、电力电子设备、变频设备、开关电源、电源系统、数字电路、检测设备、通信设备、电动设备等等设备。

公司的执行方针是：以专业的设计和可靠的质量来回馈用户的关注。

Beijing EMCARE Electronic Technology Co., Ltd. is a technology-based company specializing in the design and manufacture of EMI Power Line Filter and EMC-related products and EMC technical services. The company has a research and development team with a number of EMC professional doctors as technical leaders and strong technical force. Since its establishment, the company has always adhered to relying on professional technology and continuously provided customers with professional EMI Power Line Filter products and EMC technical services through its own technical strength. The company pays special attention to on-site technical services and personalized design for customer needs in market promotion, and finally assists customers to complete EMC design for system EMC self-compatibility and product EMC compliance.

EMI Power Line Filter products of Beijing EMCARE Electronic Technology Co., Ltd. are widely used in high-speed railway, aerospace, military equipment, medical equipment, power electronic equipment, frequency conversion equipment, switching power supply, power supply system, digital circuit, detection equipment, communication equipment, electric equipment and other equipment.

The executive policy of the company is to return users' attention with professional design and reliable quality.

PREFACE

序言

EMI滤波器的插入损耗测试方法

Test method for Insertion Loss of EMI filter

插入损耗是表征滤波器对噪声的衰减能力的参数。实际上常采用50Ω的测试系统进行测量。其定义如下：

Insertion Loss is a parameter characterizing the attenuation ability of the filter to noise. In fact, 50 Ω test system is often used for measurement. It is defined as follows:

$$IL = 20\log(V_1/V_2)$$

式中 IL:插入损耗,单位dB;

V1: 负载与信号源直接连接时,负载上的电压;

V2: 负载通过滤波器与信号源连接时,负载上的电压。

Where IL: Insertion Loss, unit: dB;

V1: voltage on the load when the load is directly connected to the signal source;

V2: voltage on the load when the load is connected to the signal source through the filter.

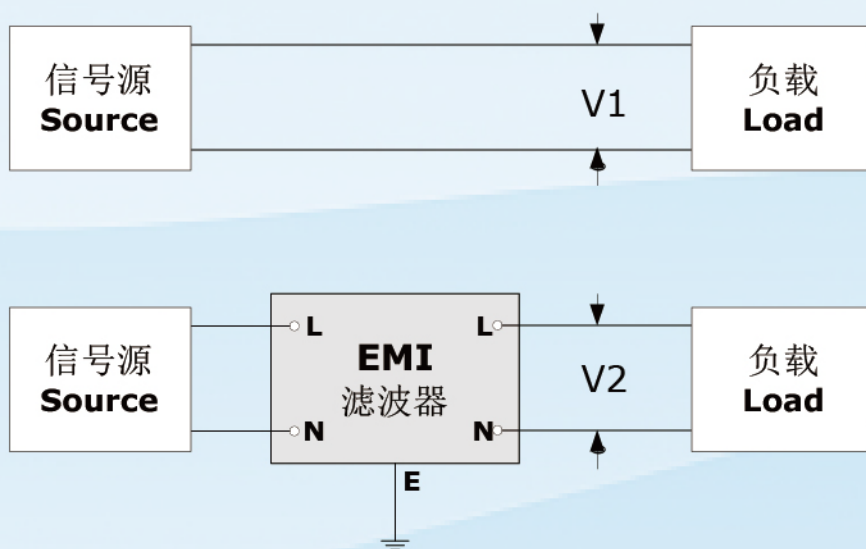

Fig.1 插入损耗定义的示意图

Fig. 1 Schematic diagram of insertion loss definition

插入损耗又分为共模插入损耗和差模插入损耗，分别表征对共模噪声和差模噪声的抑制能力。常规滤波器共/差模插入损耗的测试遵循CISPR No.17 (GB7343)的标准规定。具体测试电路如下图所示。

Insertion Loss is divided into common-mode insertion loss and differential-mode insertion loss, which respectively represent the ability to suppress common-mode noise and differential-mode noise. The common/differential mode insertion loss test of conventional filter follows the standard provisions of CISPR No.17 (GB7343). The specific test circuit is shown in the figure below.

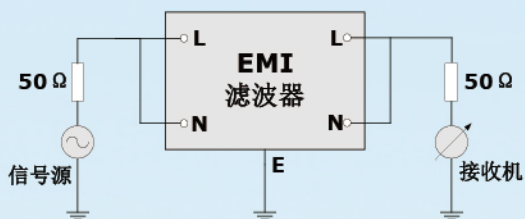

Fig.2 共模插入损耗的测试方法

Figure 2 Test method of common-mode insertion loss

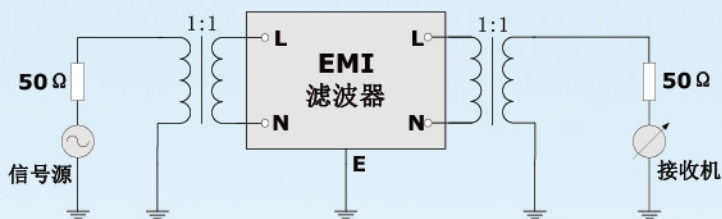

Fig.3 差模插入损耗的测试方法

Fig. 3 Test method of differential mode insertion loss

滤波器选型对策

Countermeasures for filter selection

根据应用场合来选

Select according to the application

首先需要考虑的是滤波器的类型(单相、三相、直流等等)、滤波器的额定电流和结构尺寸等因素。

The first thing to consider is the type of filter (single-phase, three-phase, DC, etc.), the rated current and structure size of the filter.

另外,实际上还常常会根据滤波器应用中特殊的耐压、漏电流、工作环境温度范围等条件来选取滤波器。

In addition, in fact, the filter is often selected according to the special withstand voltage, leakage current, operating environment temperature range and other conditions in the filter application.

根据应用标准来选

Select according to the involved standards

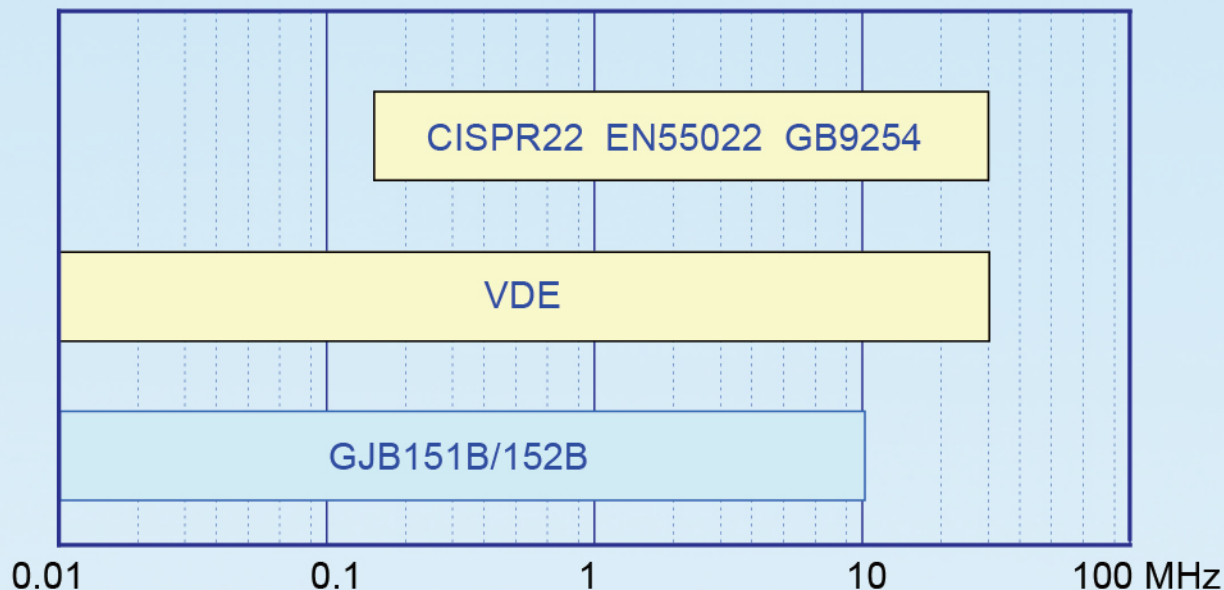

Fig.4 不同标准对传导发射所要求的测试频段

Fig.4 Test frequency band required by different standards for conducted emission

由于不同标准对传导发射测量的频段各不相同,所以在选择滤波器之前需考虑被测设备所需遵循的标准。并在对应标准所要求的频段内提出对滤波器插入损耗的要求。

Because different standards have different frequency bands for conducting emission measurement, the standards to be followed by the tested equipment should be considered before selecting the filter. The insertion loss of the filter is required within the frequency band required by the corresponding standard.

根据设备的传导发射值来选

Select according to the excess value of conducted emission of equipment

滤波器的共模插入损耗代表滤波器对共模噪声的抑制能力,而差模插入损耗则代表滤波器对差模噪声的抑制能力。理论上讲,对滤波器插入损耗的需求就等于传导发射超过标准限值的值。首先需要对噪声模式进行判断,然后计算相对应模式的插入损耗要求。

The common-mode insertion loss of the filter represents the filter's ability to suppress common-mode noise, while the differential-mode insertion loss represents the filter's ability to suppress differential-mode noise. Theoretically, the demand for filter insertion loss is equal to the value of conducted emission exceeding the standard limit. First, it is necessary to judge the noise mode, and then calculate the insertion loss requirements of the corresponding mode.

当然这只是理论计算的判断,最终还需要通过安装滤波器后所进行的实际传导发射测试来确定滤波器插损的需求值。

Of course, this is only the judgment of theoretical calculation. Finally, the required value of filter insertion loss needs to be determined through the actual conducted emission test after the filter is installed.

滤波器使用注意事项

Precautions for filter use

① 滤波器输入端在机箱内走线尽可能短

The wiring of the filter input end in the cabinet shall be as short as possible

如果滤波器的输入端在机箱内走线过长,那么滤波器的输入端在机箱内的电缆就会成为高效的接收天线,这样机箱内的噪声就会耦合到滤波器的输入端电缆上。结果会大大降低滤波器对噪声的衰减,尤其是对高频噪声。

If the input end of the filter is routed too long in the case, the cable of the input end of the filter in the case will become an efficient receiving antenna, so that the noise in the case will be coupled to the input end cable of the filter. The result will greatly reduce the noise attenuation of the filter, especially for high-frequency noise.

② 避免滤波器的输入端和输出端的耦合

Avoid coupling of the input and output ends of the filter

实际安装滤波器常常会出现滤波器输出和输入端距离过近的错误,这样由于滤波器输入和输出的耦合作用旁路了滤波器。这样的安装方法会显著降低滤波器的性能。

The error that the distance between the output and the input of the filter is too close often occurs when the filter is actually installed, which bypasses the filter due to the coupling effect of the filter input and output. Such installation method will significantly reduce the performance of the filter.

③ 滤波器可靠接地

Filter reliably grounded

滤波器可靠接地是指滤波器外壳的安装面要与机箱实现面 and 面的导电接触。而仅仅通过接地电源线接地常常在高频下表现为接地不良,这是因为在高频条件下电源线的电感使得接地阻抗剧烈上升而导致滤波器出现高阻接地的情况。

The reliable grounding of the filter refers to the conductive contact between the mounting surface of the filter and the surface of the chassis. However, grounding only through the grounding power line often shows poor grounding at high frequency. This is because the inductance of the power line causes a sharp rise in the grounding impedance at high frequency, resulting in high resistance grounding of the filter.



SINGLE-PHASE FILTERS

单相滤波器

单相通用系列

Single-Phase Series for General Purpose

单相高性能系列

High Performance Single-Phase Series

单相超高性能系列

Ultra-high Performance Single-Phase Series

高压系列

High Voltage Series

医用低漏电系列

Medical Low Leakage Series

单相通用系列

Single-Phase Series for General Purpose

- ◎ 结构紧凑, 安装方便
Compact structure and convenient installation
- ◎ 高性价比
High cost performance
- ◎ 适合各种通用单相电子设备
Suitable for general single-phase electronic equipment

技术规格 Specification

额定电压 Rated Voltage	250VAC		
工作频率 Operating Frequency	50/60Hz		
介质耐压 Hipot Test Voltage	线-线(L-L)	1768VDC	1分钟 1min
	线-地(L-E)	2000VAC	
气候等级 Climatic Classification	25/085/21		遵循IEC68-1标准 Per IEC68-1 standard

型号 Model	额定电流 Rated Current	电路原理 Electrical Schematics	最大漏电流 Max. Leakage	外形尺寸 Mechanical Data	端接方式 Connections	
					输入 Input	输出 Output
S110-1DW	1A	Fig.1	<0.3mA	Fig.1		
S110-3DW	3A	Fig.1	<0.3mA	Fig.1		
S110-6DW	6A	Fig.1	<0.3mA	Fig.1		
S110-10BL	10A	Fig.1	<0.5mA	Fig.2		
S110-20BL	20A	Fig.1	<0.5mA	Fig.2		

单相滤波器

SINGLE-PHASE FILTERS

单相通用系列

Single-Phase Series for General Purpose

05

单相滤波器



型号	额定电流	电路原理	最大漏电流	外形尺寸	端接方式	
Model	Rated Current	Electrical Schematics	Max. Leakage	Mechanical Data	Connections	
					输入 Input	输出 Output
S120-1DW	1A	Fig.2	<0.5mA	Fig.1		
S120-3DW	3A	Fig.2	<0.5mA	Fig.1		
S120-6BL	6A	Fig.2	<0.5mA	Fig.2		
S120-10BL	10A	Fig.2	<0.5mA	Fig.2		
S120-20BL	20A	Fig.2	<0.5mA	Fig.2		
S120-30CS	30A	Fig.2	<0.5mA	Fig.3		
S120-50ES	50A	Fig.2	<0.5mA	Fig.4		
S120-100GS	100A	Fig.2	<0.5mA	Fig.5		

*漏电流测试条件为250VAC/50Hz

*The leakage current test condition is 250VAC/50Hz



插入损耗
Insertion Loss

遵循CISPR No.17/GB7343标准,插入损耗是在输入/输出均为50Ω的条件下的测量值。

CM (共模) _____ DM (差模) _____

According to CISPR No.17/GB7343 standard, the insertion loss is the measured value under the condition that the input/output is 50 Ω.

_____ denotes Common Mode Insertion Loss, _____ denotes Differential Mode Insertion Loss.



S120-3DW

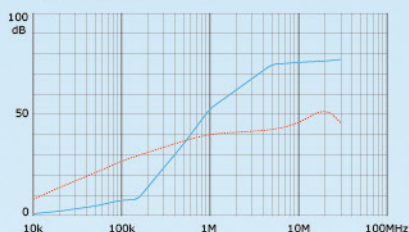

S120-6BL

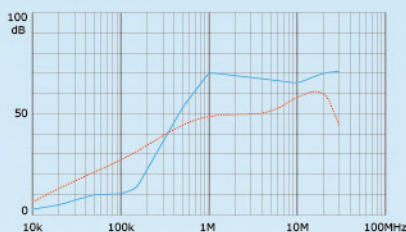

S120-10BL

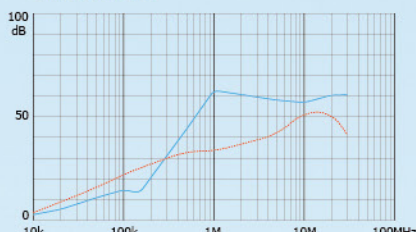

S120-20BL

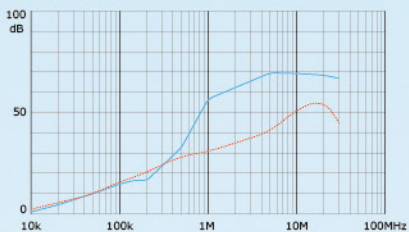

S120-30CS

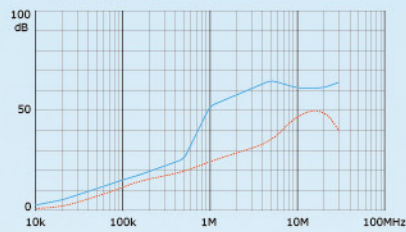

S120-50ES

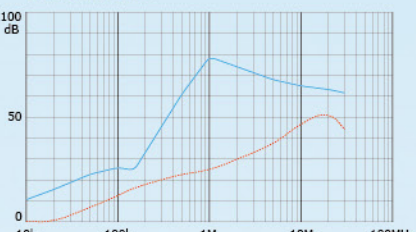

S120-100GS

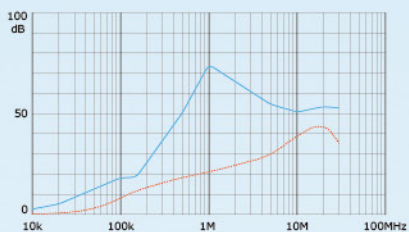

电路原理
Electrical Schematics

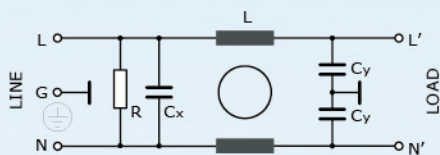

Fig.1

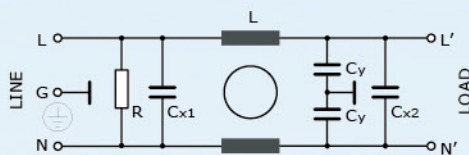

Fig.2



外形尺寸
Mechanical Data

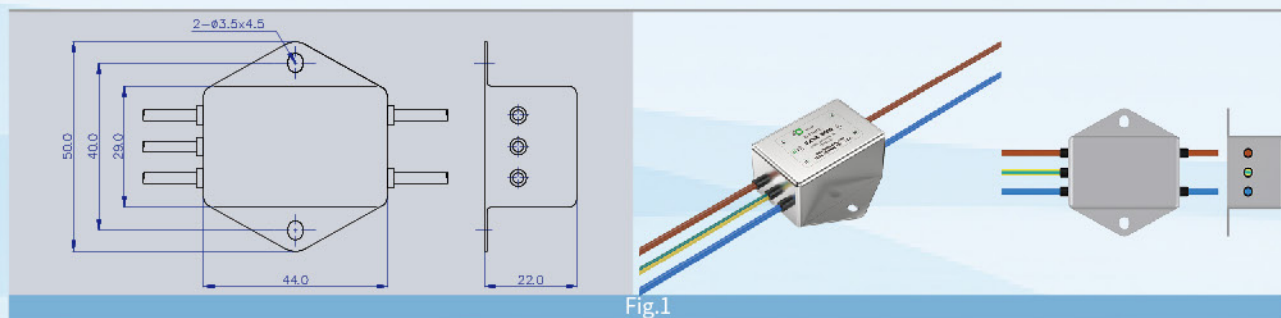

Fig.1

单相滤波器

SINGLE-PHASE FILTERS

单相通用系列

Single-Phase Series for General Purpose

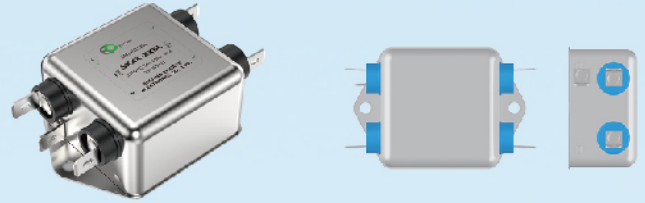
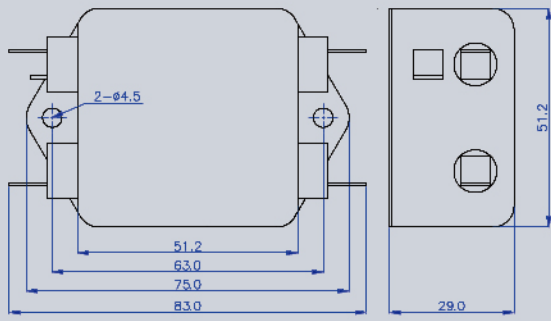

Fig.2

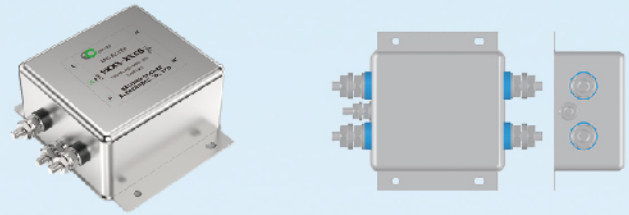
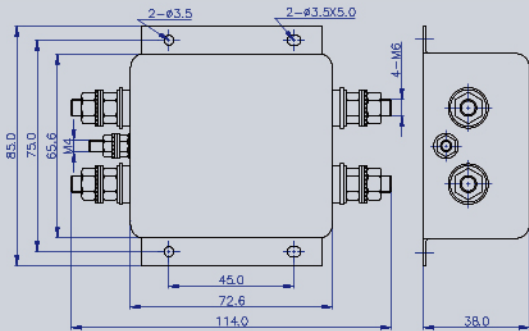

Fig.3

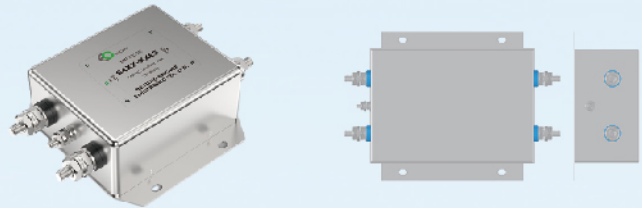
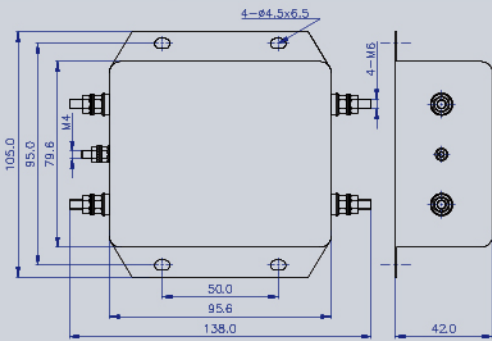

Fig.4

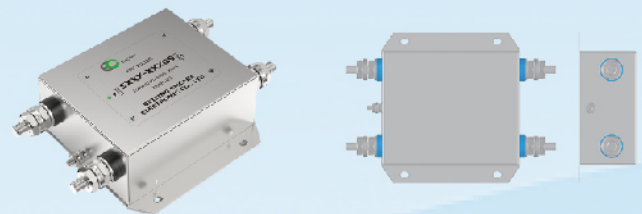
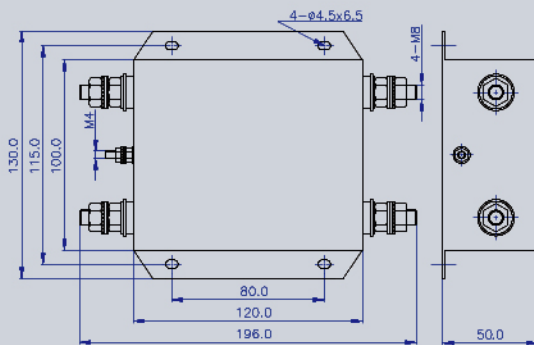

Fig.5

单相高性能系列

High Performance Single-Phase Series

- ◎ 优良的共模/差模干扰抑制性能
Excellent common mode/differential mode interference suppression performance
- ◎ 适合各种对噪声抑制需要较高的电子设备中
Suitable for all kinds of electronic equipment with high requirements for noise suppression
- ◎ 尤其适用CISPR11、CISPR14、CISPR22规定的传导发射测试
Particularly applicable to CE test specified in CISPR11, CISPR14 and CISPR22
- ◎ 特别对电子设备通过EFT等测试实验效果显著
Especially for electronic equipment passing EFT

技术规格 Specification

额定电压 Rated Voltage	250VAC		
工作频率 Operating Frequency	50/60Hz		
介质耐压 Hipot Test Voltage	线-线(L-L)	1768VDC	1分钟 1min
	线-地(L-E)	2000VAC	
气候等级 Climatic Classification	25/085/21		遵循IEC68-1标准 Per IEC68-1 standard

型号 Model	额定电流 Rated Current	电路原理 Electrical Schematics	最大漏电流 Max. Leakage	外形尺寸 Mechanical Data	端接方式 Connections	
					输入 Input	输出 Output
S210-1AW	1A	Fig.1	<0.3mA	Fig.1	⋮	⋮
S210-3AW	3A	Fig.1	<0.3mA	Fig.1	⋮	⋮
S210-6AW	6A	Fig.1	<0.3mA	Fig.1	⋮	⋮

单相滤波器

SINGLE-PHASE FILTERS

单相高性能系列

High Performance Single-Phase Series

09



型号	额定电流	电路原理	最大漏电流	外形尺寸	端接方式	
Model	Rated Current	Electrical Schematics	Max. Leakage	Mechanical Data	Connections	
					输入 Input	输出 Output
S220-1AW	1A	Fig.2	<0.3mA	Fig.1		
S220-3HL	3A	Fig.2	<0.3mA	Fig.2		
S220-6HL	6A	Fig.2	<0.5mA	Fig.2		
S221-6HL	6A	Fig.2	<0.5mA	Fig.3		
S220-10HL	10A	Fig.2	<0.5mA	Fig.2		
S220-16HL	16A	Fig.2	<0.5mA	Fig.3		
S220-20HS	20A	Fig.2	<0.5mA	Fig.4		
S220-30ES	30A	Fig.2	<0.5mA	Fig.5		
S220-50FS	50A	Fig.2	<0.5mA	Fig.6		

*漏电流测试条件为250VAC/50Hz

*The leakage current test condition is 250VAC/50Hz



插入损耗
Insertion Loss

遵循CISPR No.17/GB7343标准,插入损耗是在输入/输出均为50Ω的条件下的测量值。

CM (共模) _____ DM (差模) _____

According to CISPR No.17/GB7343 standard, the insertion loss is the measured value under the condition that the input/output is 50 Ω.

_____ denotes Common Mode Insertion Loss, _____ denotes Differential Mode Insertion Loss.

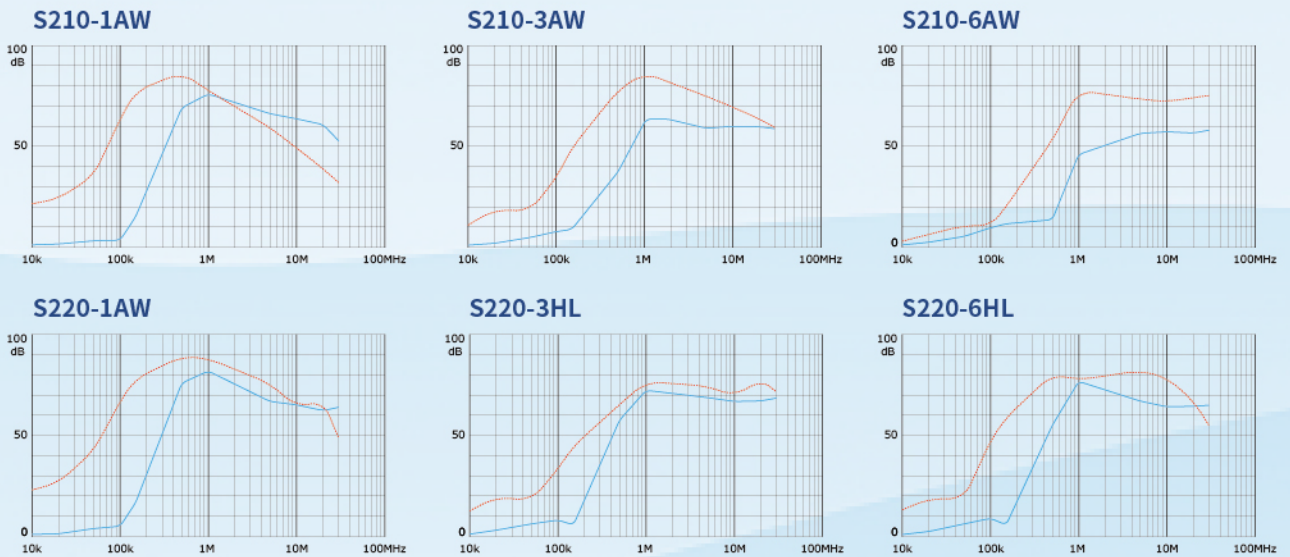

10

单相滤波器

SINGLE-PHASE FILTERS

单相高性能系列

High Performance Single-Phase Series

S221-6HL

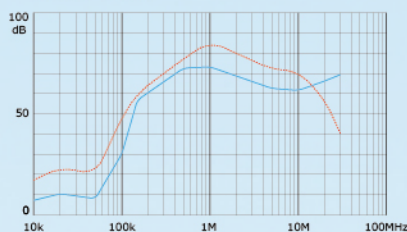

S220-10HL

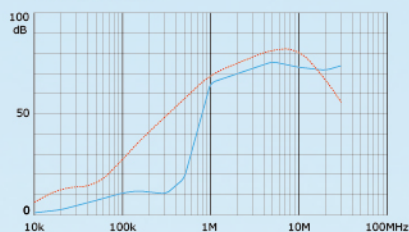

S220-16HL

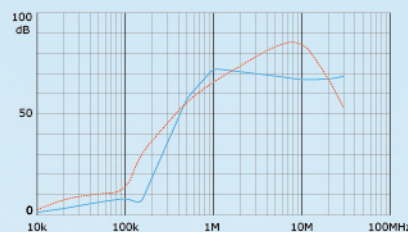

S220-20HS

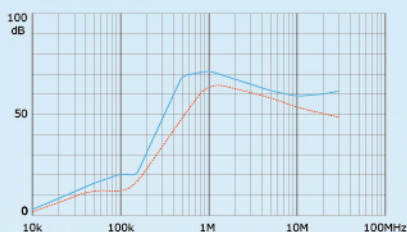

S220-30ES

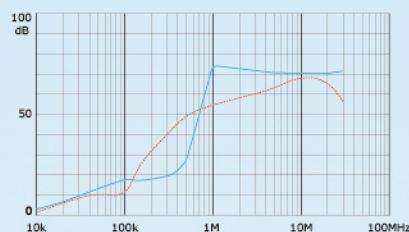

S220-50FS

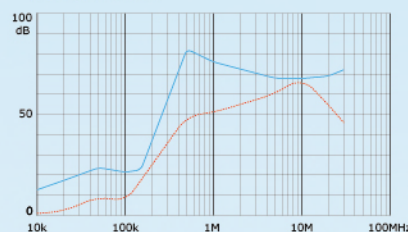

电路原理
Electrical Schematics

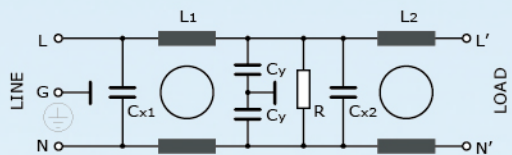

Fig.1

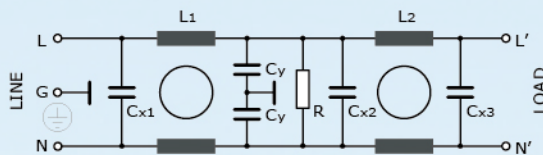

Fig.2



外形尺寸
Mechanical Data

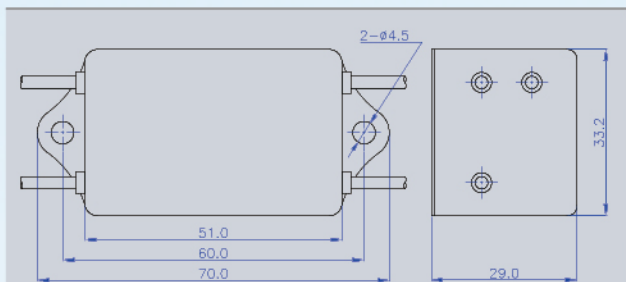

Fig.1

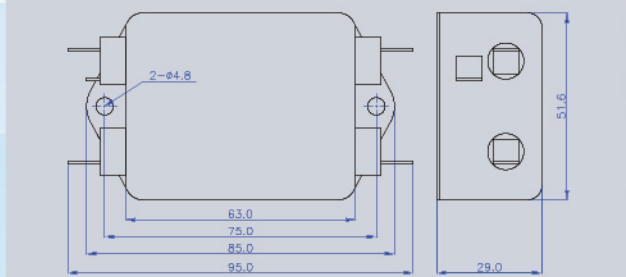
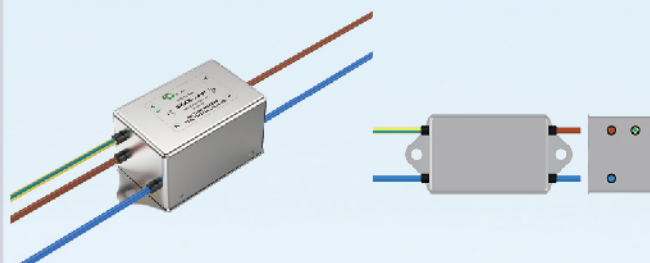
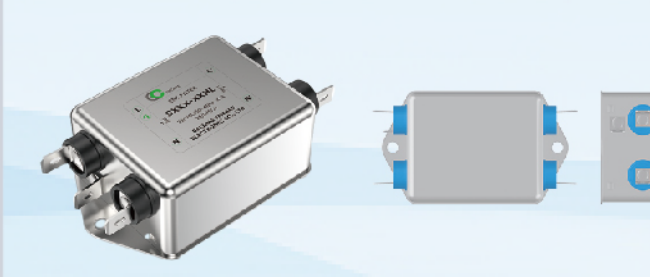

Fig.2



单相滤波器

SINGLE-PHASE FILTERS

单相高性能系列

High Performance Single-Phase Series

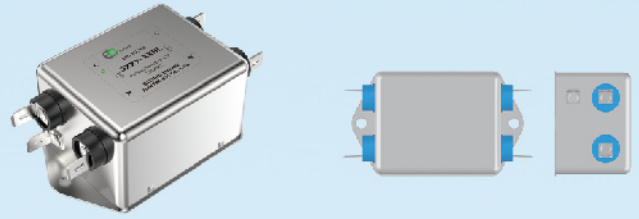
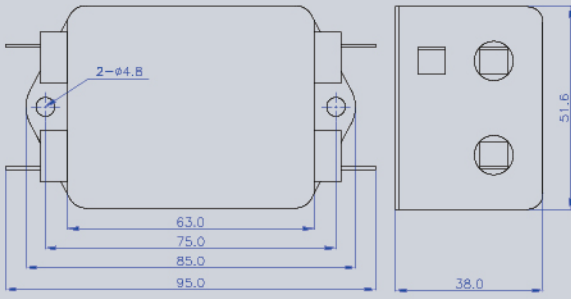

Fig.3

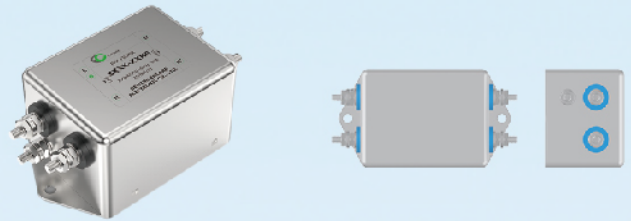
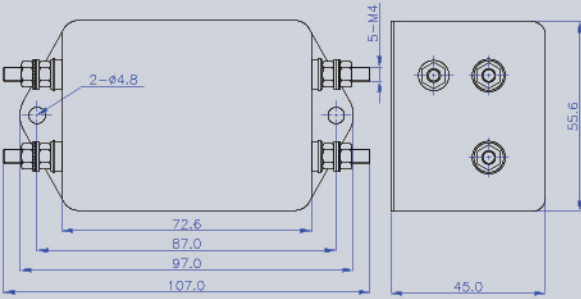

Fig.4

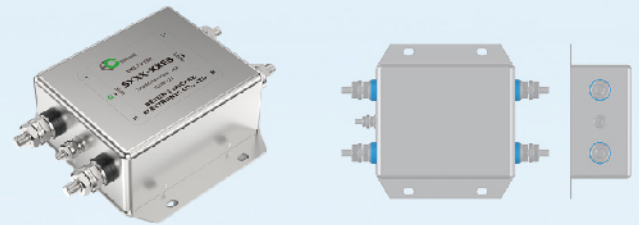
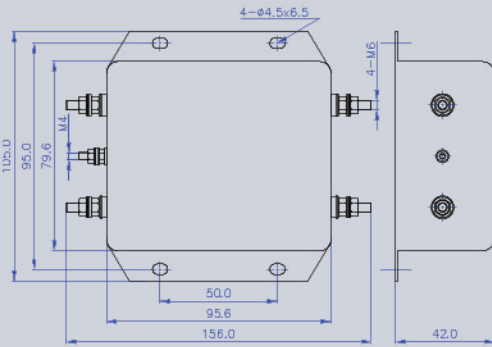

Fig.5

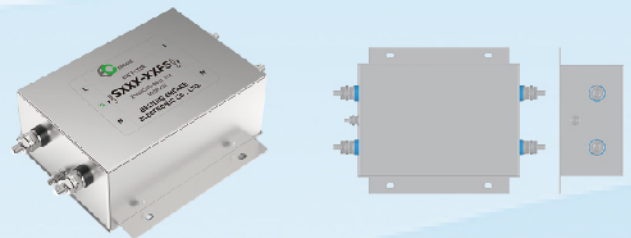
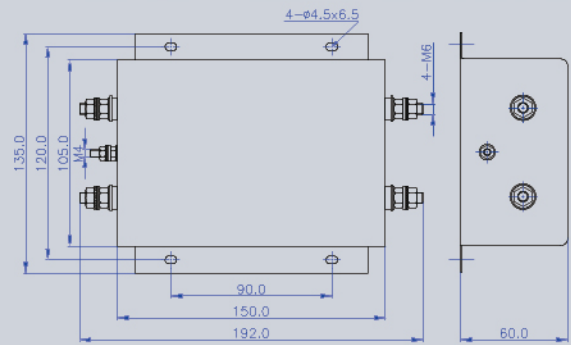

Fig.6

单相超高性能系列

Ultra-high Performance Single-Phase Series

- ◎ 优异的共/差模插入损耗性能
Super strong common mode/differential mode interference suppression performance
- ◎ 优秀的低频性能
Very high performance for low frequency noise
- ◎ 解决变频器产生的EMC和EMI问题
To Handle the EMC and EMI problem caused by converter

技术规格 Specification

额定电压 Rated Voltage	250VAC	
工作频率 Operating Frequency	50/60Hz	
介质耐压 Hipot Test Voltage	线-线(L-L)	1768VDC
	线-地(L-E)	2000VAC
气候等级 Climatic Classification	25/085/21	遵循IEC68-1标准 Per IEC68-1 standard

型号 Model	额定电流 Rated Current	电路原理 Electrical Schematics	最大漏电流 Max. Leakage	外形尺寸 Mechanical Data	端接方式 Connections	
					输入 Input	输出 Output
S310-3BL	3A	Fig.1	<0.5mA	Fig.1		
S310-6CS	6A	Fig.1	<0.5mA	Fig.2		
S320-3HL	3A	Fig.2	<0.5mA	Fig.3		
S320-6ES	6A	Fig.2	<0.5mA	Fig.4		
S320-10ES	10A	Fig.2	<0.5mA	Fig.4		
S320-20ES	20A	Fig.2	<0.5mA	Fig.5		

单相滤波器

单相滤波器

SINGLE-PHASE FILTERS

单相超高性能系列

Ultra-high Performance Single-Phase Series



型号	额定电流	电路原理	最大漏电流	外形尺寸	端接方式	
Model	Rated Current	Electrical Schematics	Max. Leakage	Mechanical Data	Connections	
					输入 Input	输出 Output
S320-20FS	20A	Fig.2	<0.5mA	Fig.6		
S320-30FS	30A	Fig.2	<0.5mA	Fig.6		

*漏电流测试条件为250VAC/50Hz

*The leakage current test condition is 250VAC/50Hz



插入损耗
Insertion Loss

遵循CISPR No.17/GB7343标准,插入损耗是在输入/输出均为50Ω的条件下的测量值。

CM (共模) —— DM (差模) ——

According to CISPR No.17/GB7343 standard, the insertion loss is the measured value under the condition that the input/output is 50 Ω.

—— denotes Common Mode Insertion Loss, —— denotes Differential Mode Insertion Loss.

S310-3BL

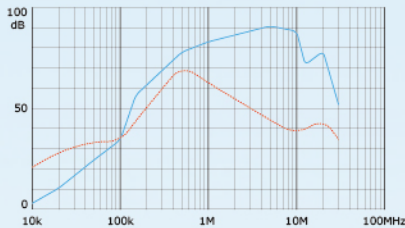

S310-6CS

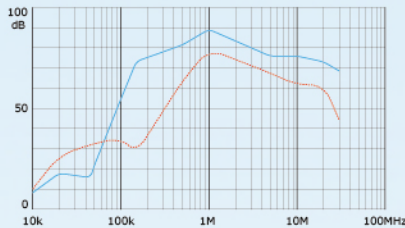

S320-3HL

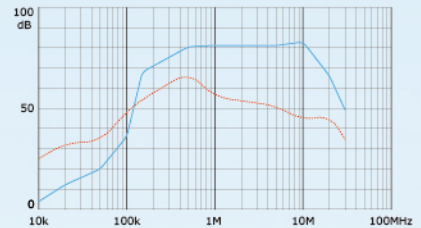

S320-6ES

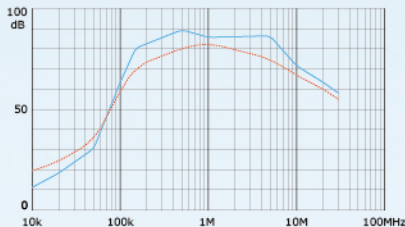

S320-10ES

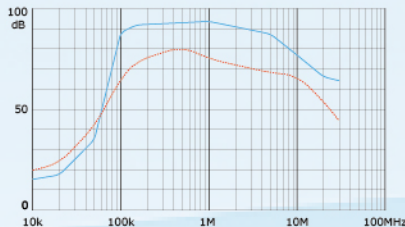

S320-20ES

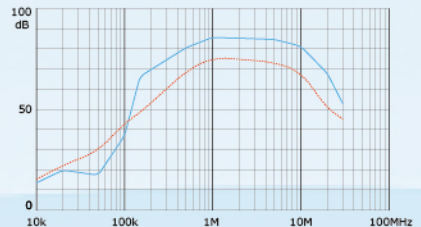

S320-20FS

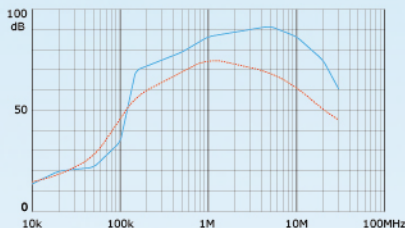

S320-30FS

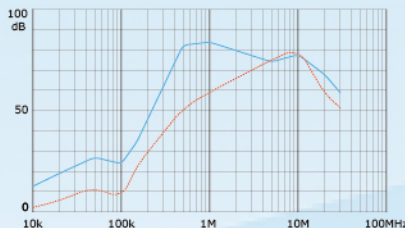

电路原理
Electrical Schematics

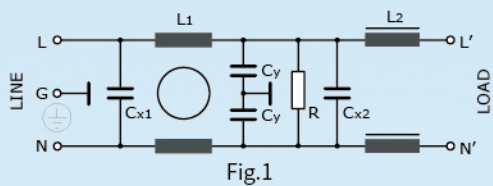

Fig.1

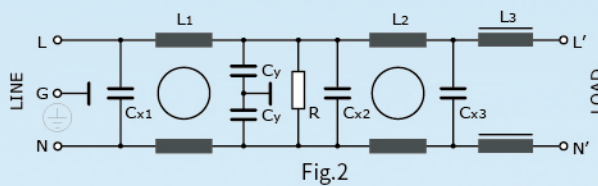

Fig.2

外形尺寸
Mechanical Data

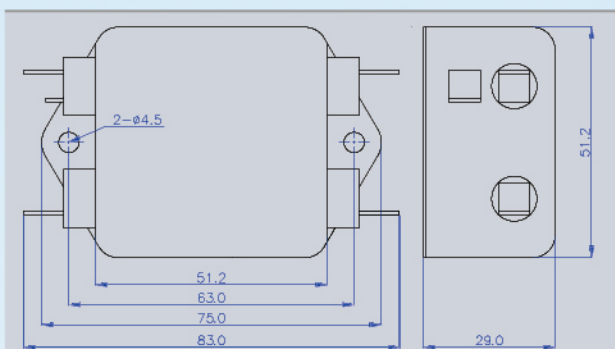

Fig.1

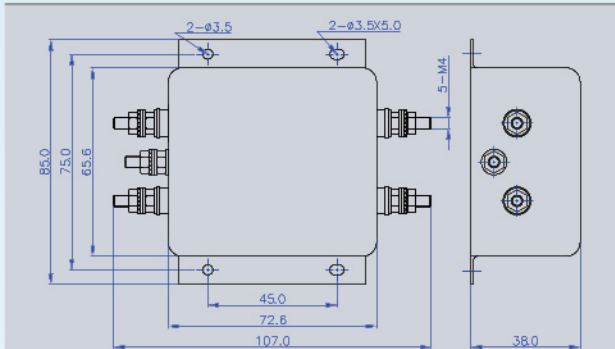
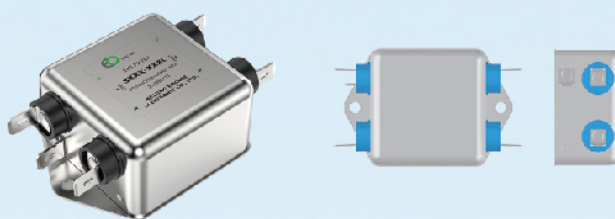

Fig.2

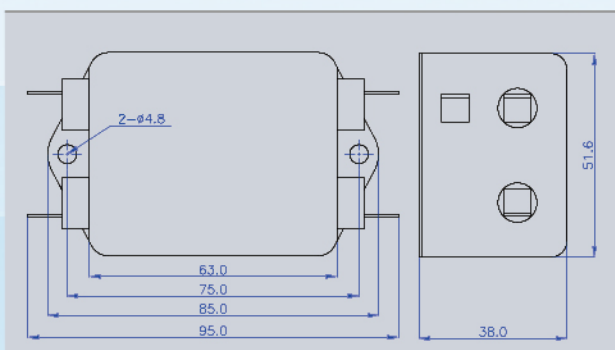
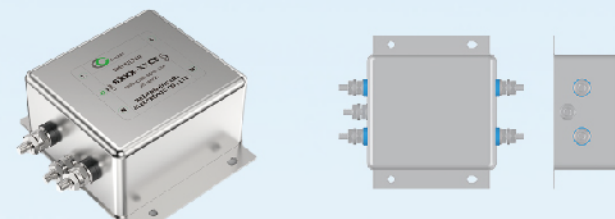
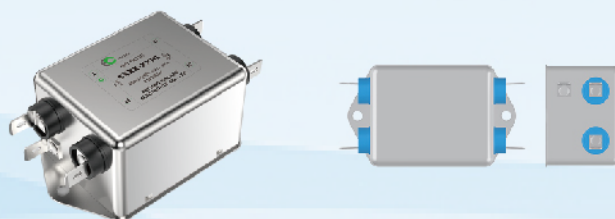

Fig.3



单相滤波器

SINGLE-PHASE FILTERS

单相超高性能系列

Ultra-high Performance Single-Phase Series

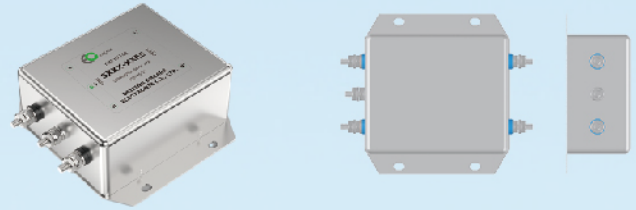
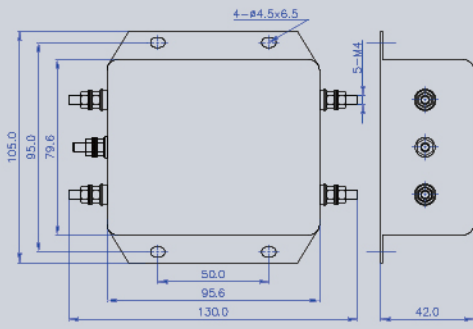

Fig.4

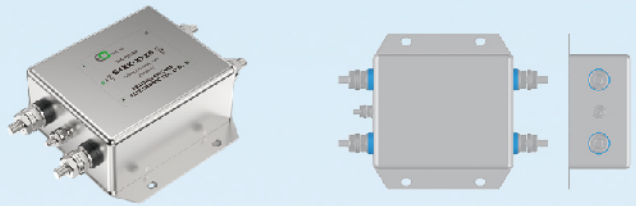
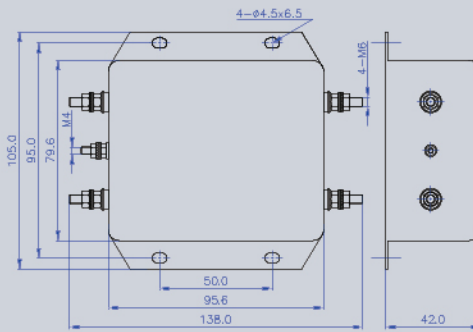

Fig.5

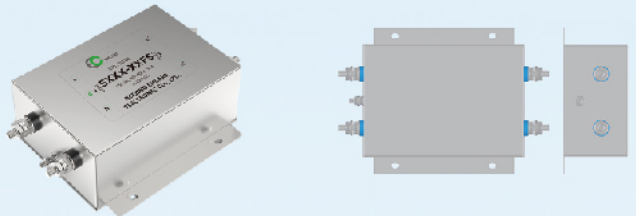
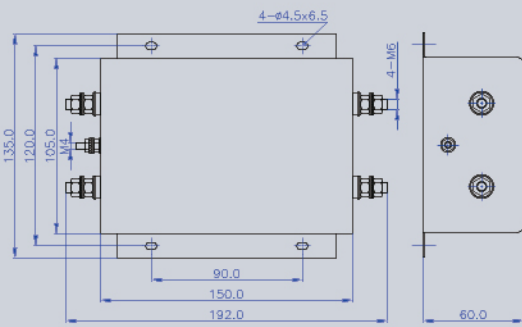

Fig.6

高压系列

High Voltage Series

- ④ 440VAC额定电压, 具有高介质耐压值
440VAC rated voltage, Hipot test voltage
- ④ 优良的共模、差模干扰抑制性能
Excellent common and differential mode attenuation
- ④ 适合各种对噪声抑制需要较高的电子设备中
Suitable for electrical equipment with high performance requirement for noise attenuation

技术规格 Specification

额定电压 Rated Voltage	440VAC		
工作频率 Operating Frequency	50/60Hz		
介质耐压 Hipot Test Voltage	线-线(L-L)	2250VDC	1分钟 1min
	线-地(L-E)	2700VDC	
气候等级 Climatic Classification	25/085/21		遵循IEC68-1标准 Per IEC68-1 standard

型号 Model	额定电流 Rated Current	电路原理 Electrical Schematics	最大漏电流 Max. Leakage	外形尺寸 Mechanical Data	端接方式 Connections	
					输入 Input	输出 Output
S430-3AW	3A	Fig.1	<0.3mA	Fig.1		
S440-3HL	3A	Fig.2	<0.3mA	Fig.2		
S440-6HL	6A	Fig.2	<0.3mA	Fig.2		
S440-10HL	10A	Fig.2	<0.3mA	Fig.3		
S440-16HL	16A	Fig.2	<0.5mA	Fig.3		
S440-20ES	20A	Fig.2	<0.5mA	Fig.4		
S440-30ES	30A	Fig.2	<0.5mA	Fig.4		

*漏电流测试条件为250VAC/50Hz

*The leakage current test condition is 250VAC/50Hz



北京爱科创业电子技术有限公司
Beijing EMCARE Electronic Technology Co., Ltd.



插入损耗
Insertion Loss

遵循CISPR No.17/GB7343标准,插入损耗是在输入/输出均为50Ω的条件下的测量值。

CM (共模) _____ DM (差模) _____

According to CISPR No.17/GB7343 standard, the insertion loss is the measured value under the condition that the input/output is 50 Ω.

_____ denotes Common Mode Insertion Loss, _____ denotes Differential Mode Insertion Loss.

S430-3AW

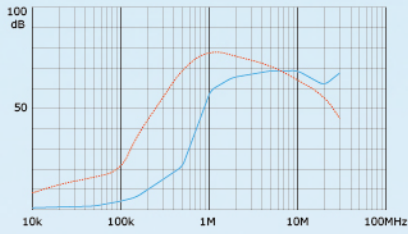

S440-3HL

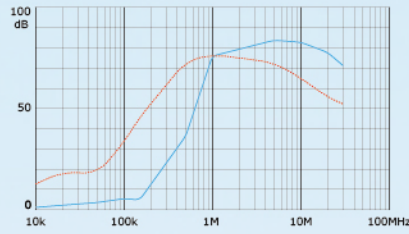

S440-6HL

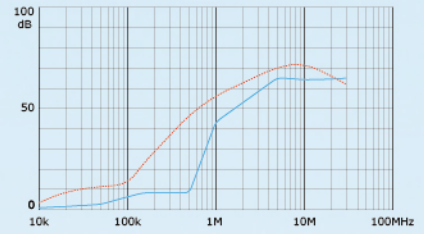

S440-10HL

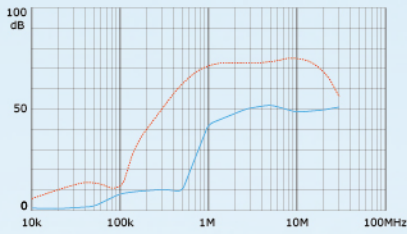

S440-16HL

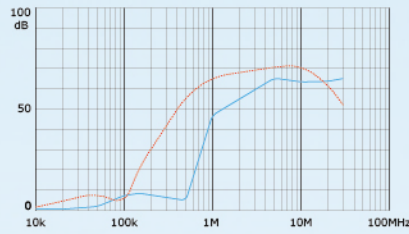

S440-20ES

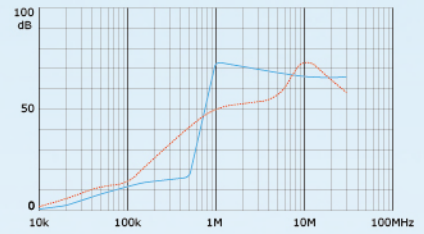

S440-30ES

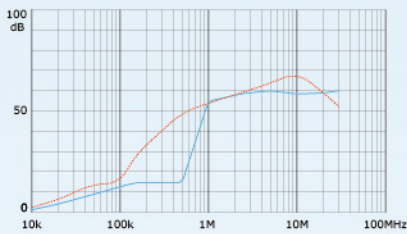

电路原理
Electrical Schematics

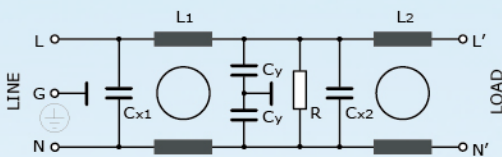

Fig.1

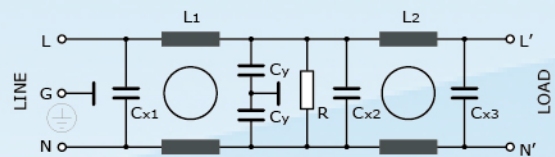

Fig.2

18

单相滤波器

SINGLE-PHASE FILTERS

高压系列
High Voltage Series

外形尺寸
Mechanical Data

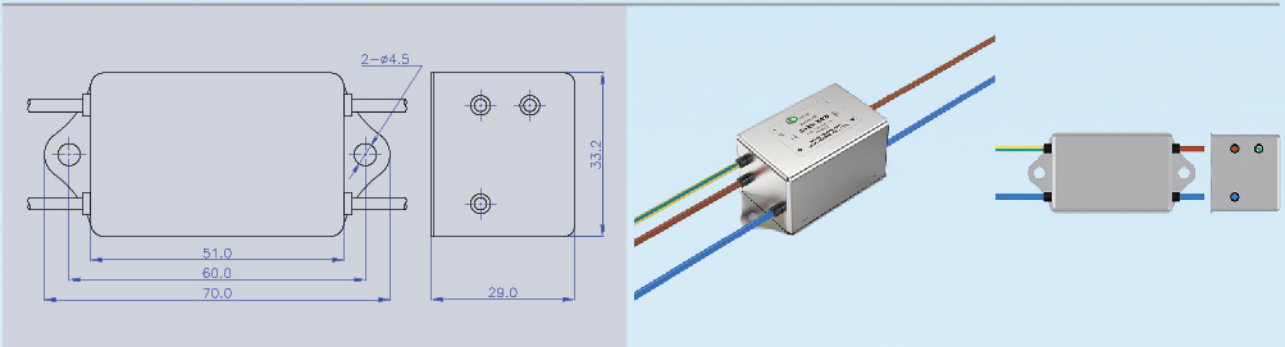

Fig.1

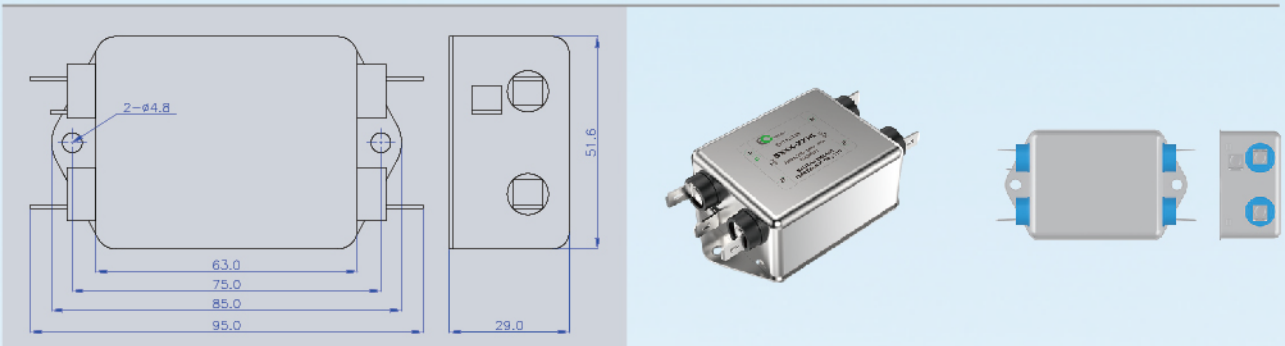

Fig.2

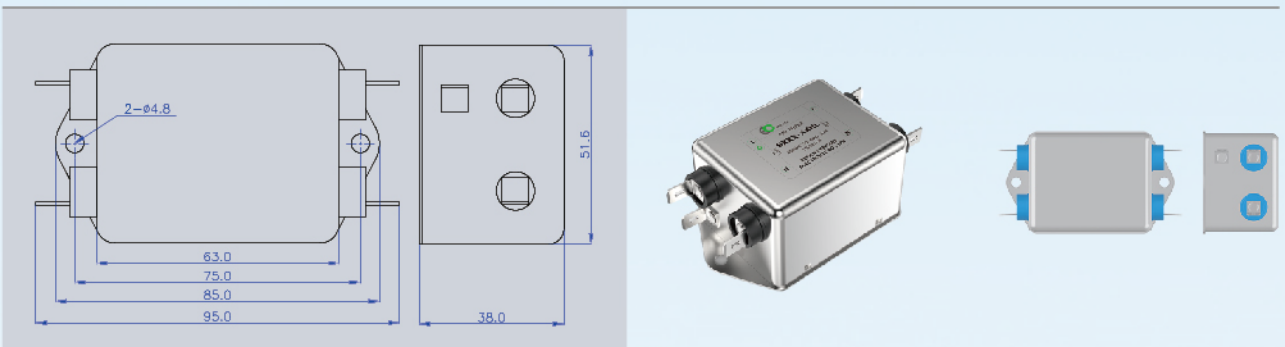

Fig.3

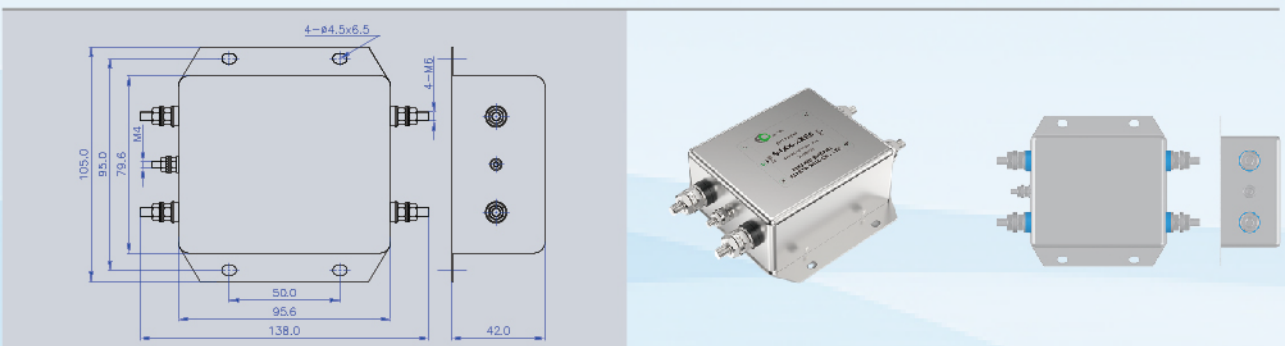

Fig.4



医用低漏电系列

Medical Low Leakage Series

◎ 极低的漏电流

Very low leakage current

◎ 适合医疗用途的电子设备

Suitable for medical electrical equipment



技术规格

Specification

额定电压 Rated Voltage	250VAC		
工作频率 Operating Frequency	50/60Hz		
介质耐压 Hipot Test Voltage	线-线(L-L)	1768VDC	1分钟 1min
	线-地(L-E)	2000VAC	
气候等级 Climatic Classification	25/085/21		遵循IEC68-1标准 Per IEC68-1 standard

型号 Model	额定电流 Rated Current	电路原理 Electrical Schematics	最大漏电流 Max. Leakage	外形尺寸 Mechanical Data	端接方式 Connections	
					输入 Input	输出 Output
S54L-3HL	3A	Fig.1	<0.08mA	Fig.1		
S54L-6HL	6A	Fig.1	<0.08mA	Fig.1		
S54L-10HL	10A	Fig.1	<0.08mA	Fig.1		
S54L-20HS	20A	Fig.1	<0.08mA	Fig.2		
S56L-3HL	3A	Fig.2	<0.08mA	Fig.3		
S56L-6ES	6A	Fig.2	<0.08mA	Fig.4		
S56L-10ES	10A	Fig.2	<0.08mA	Fig.4		
S56L-20FS	20A	Fig.2	<0.08mA	Fig.5		
S540-3HL	3A	Fig.1	<0.15mA	Fig.1		

20

单相滤波器

SINGLE-PHASE FILTERS

医用低漏电系列

Medical Low Leakage Series

型号	额定电流	电路原理	最大漏电流	外形尺寸	端接方式	
Model	Rated Current	Electrical Schematics	Max. Leakage	Mechanical Data	Connections	
					输入 Input	输出 Output
S540-6HL	6A	Fig.1	<0.15mA	Fig.1		
S540-10HL	10A	Fig.1	<0.15mA	Fig.1		
S540-20HS	20A	Fig.1	<0.15mA	Fig.2		
S560-3HL	3A	Fig.2	<0.15mA	Fig.3		
S560-6ES	6A	Fig.2	<0.15mA	Fig.4		
S560-10ES	10A	Fig.2	<0.15mA	Fig.4		
S560-20FS	20A	Fig.2	<0.15mA	Fig.5		

*漏电流测试条件为250VAC/50Hz

*The leakage current test condition is 250VAC/50Hz

插入损耗
Insertion Loss

遵循CISPR No.17/GB7343标准, 插入损耗是在输入/输出均为50Ω的条件下的测量值。

CM (共模) DM (差模)

According to CISPR No.17/GB7343 standard, the insertion loss is the measured value under the condition that the input/output is 50 Ω.

denotes Common Mode Insertion Loss, denotes Differential Mode Insertion Loss.

S54L-3HL

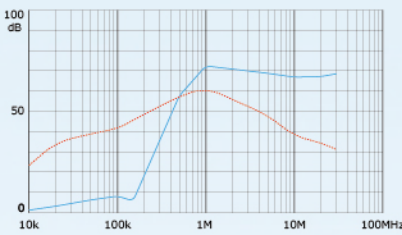

S54L-6HL

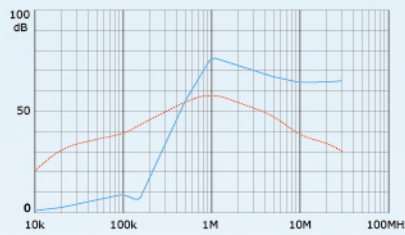

S54L-10HL

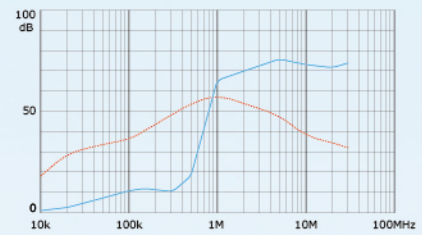

S54L-20HS

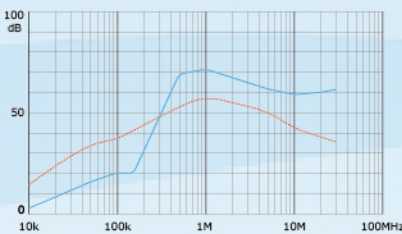

S56L-3HL

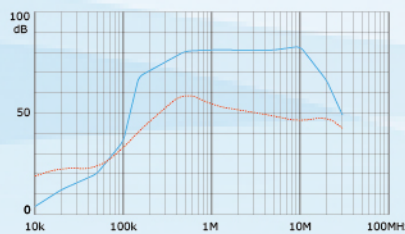

S56L-6ES

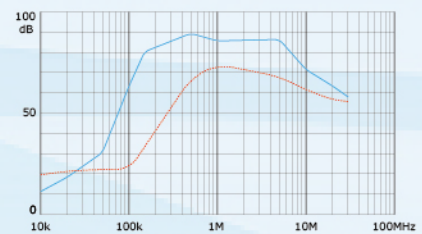

单相滤波器

SINGLE-PHASE FILTERS

医用低漏电系列

Medical Low Leakage Series



S56L-10ES

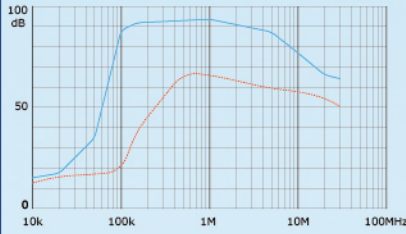

S56L-20FS

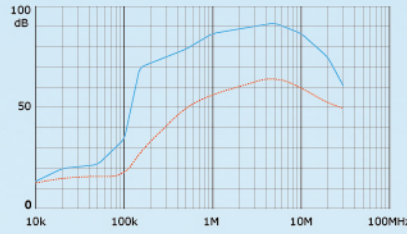

S540-3HL

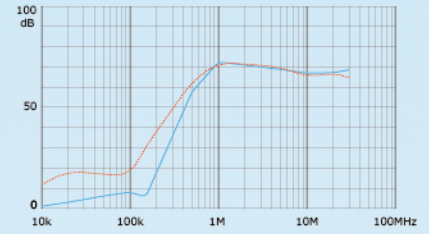

S540-6HL

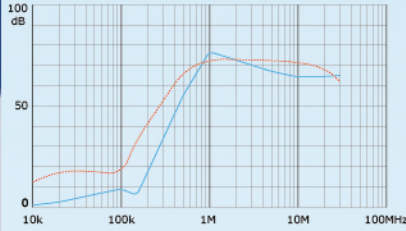

S540-10HL

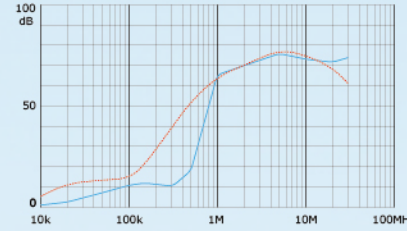

S540-20HS

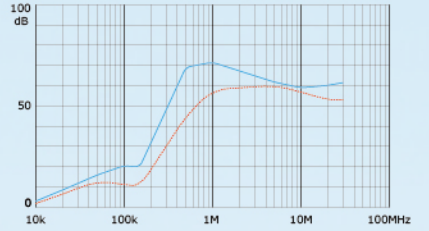

S560-3HL

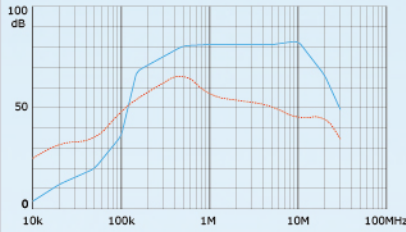

S560-6ES

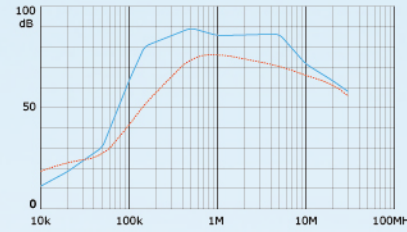

S560-10ES

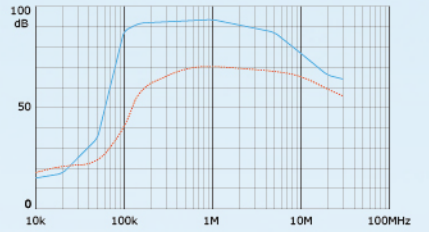

S560-20FS

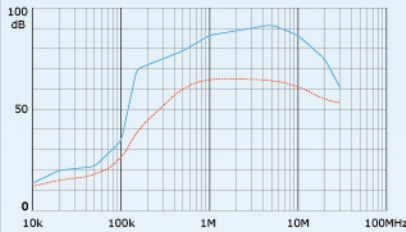

电路原理

Electrical Schematics

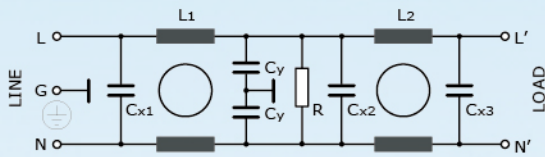

Fig.1

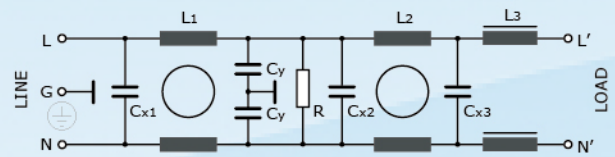

Fig.2

外形尺寸
Mechanical Data

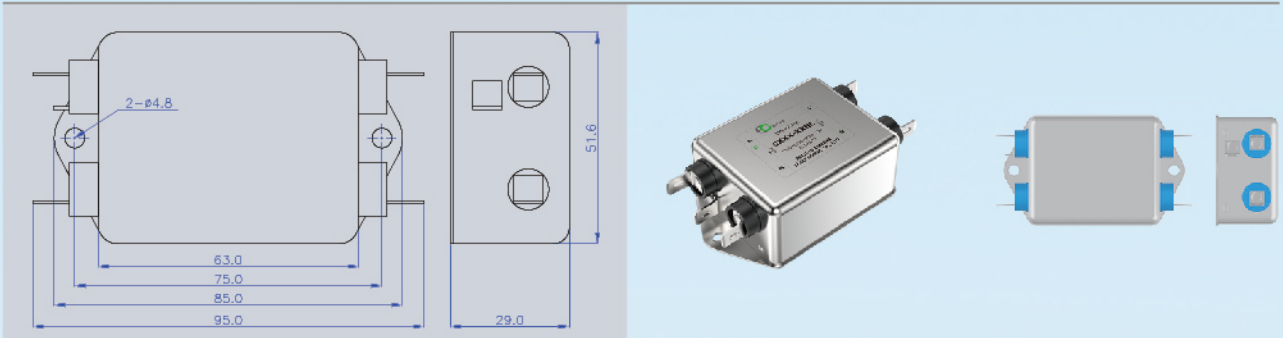

Fig.1

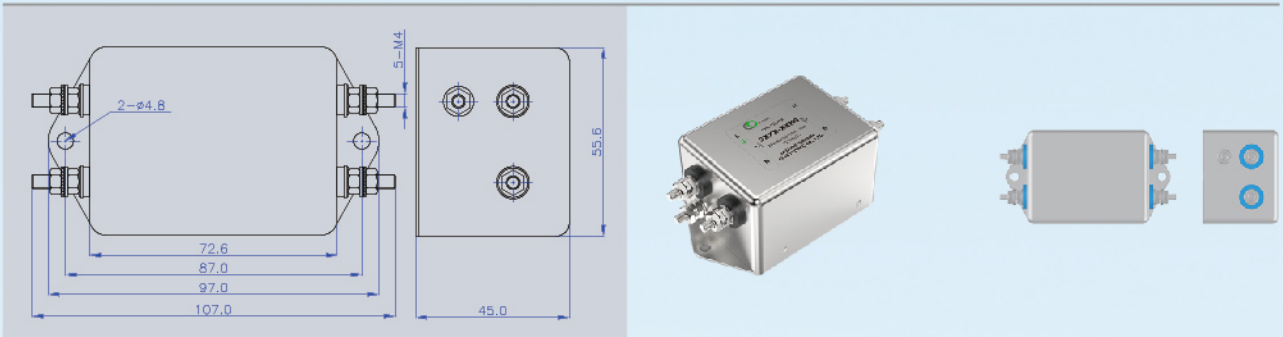

Fig.2

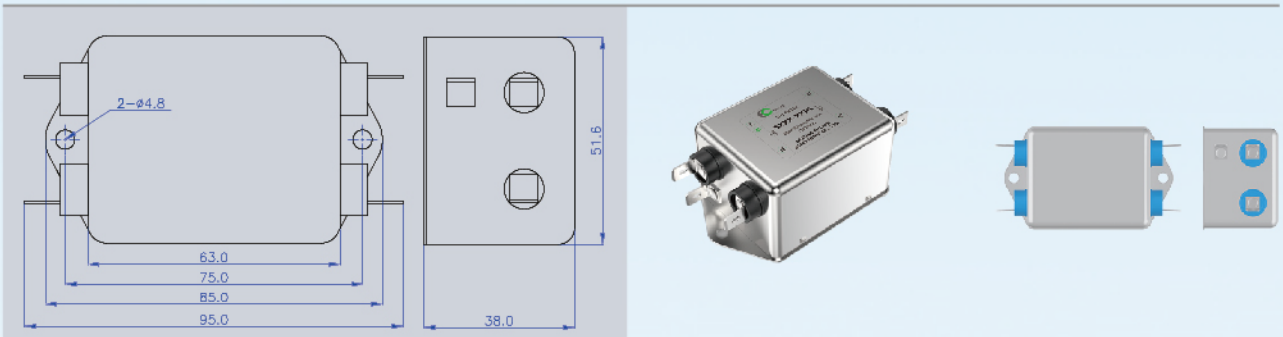
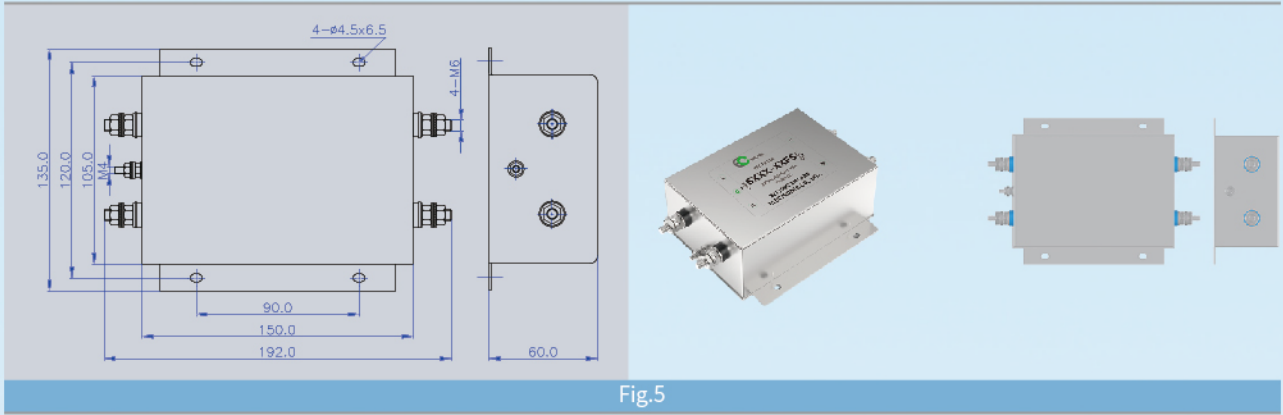

Fig.3



Fig.4



单相滤波器

24

单相滤波器

SINGLE-PHASE FILTERS

医用低漏电系列

Medical Low Leakage Series

北京爱科创业电子技术有限公司

Beijing EMCARE Electronic Technology Co.,Ltd.

 010-82922019

 400-0160-309

 010-82922657

 www.emcare.com.cn

 sales@emcare.com.cn



企业微信



淘宝自营